

dixell

iCHiLL

Instruction Manual



INDEX

1.	General Advices	2
2.	User Interface	3
3.	Key Function	3
4.	Keyboard Leds	4
5.	Remote Keyboard VI610	4
6.	Normal Condition read-out	4
7.	Silencing the Buzzer	5
8.	First Installing	5
9.	How to Set the Clock RTC	5
10.	“ Hot Key” Programming	5
11.	Keyboard Programming	5
12.	Change the Password	6
13.	Value of Display Read-Out Par. CF36	6
14.	Start / Stop Chiller or Heat Pump	7
15.	Stand- By Function	7
16.	“M key” the Function Menu	7
17.	Keyboard Functions	8
18.	How to Turn a Compressor in Off-Line	8
19.	Dynamic Set Point	8
20.	Energy Saving	9
21.	Compressor Functioning	9
22.	Condenser Fan Regulation	10
23.	Hot Start Function	11
24.	Automatic Change - Over	11
25.	Defrost Function	11
26.	Relay Configuration	12
27.	Data Logger	12
28.	Boiler Function	12
29.	Maintenance Function	12
30.	Black Out	12
31.	Installing and Mounting	12
32.	Electrical Wiring	13
33.	Alarm Code and Events	14
34.	Output Lock for Alarm Event Table	17
35.	Connecting Diagram	18
36.	Parameter description	19
37.	Parameter Table	27
38.	Technical Data	38

1. GENERAL ADVICES



- Please read before using this manual
- This manual is part of the product and should be kept near the instrument for easy and quick reference.
- The instrument shall not be used for purposes different from those described hereunder. It cannot be used as a safety device.
- Check the application limits before proceeding.



1.1 Safety Precaution

- Check the supply voltage is correct before connecting the instrument.
- Do not expose to water or moisture: use the controller only within the operating limits avoiding sudden temperature changes with high atmospheric humidity to prevent formation of condensation
- Warning: disconnect all electrical connections before any kind of maintenance.
- Fit the probe where it is not accessible by the End User. The instrument must not be opened.
- In case of failure or faulty operation send the instrument back to the distributor or to “Dixell s.r.l.” (see address) with a detailed description of the fault.
- Consider the maximum current which can be applied to each relay (see Technical Data).
- Ensure that the wires for probes, loads and the power supply are separated and far enough from each other, without crossing or intertwining.
- In case of applications in industrial environments, the use of mains filters (our mod. FT1) in parallel with inductive loads could be useful.

2. USER INTERFACE



2.1 Display

The display area is divided in three parts:

Left Upper Side : It shows the evaporator "water IN / OUT" temperature or the inlet air of the air/air unit.

Left Lower Side : It shows the temperature or the pressure of the condenser and the clock time.

Right Side: Icon area.

2.2 Icons of the Display

Icon	Meaning
°C	Celsius degrees
°F	Fahrenheit degrees
bar	Bar
PSI	Psi
	Compressor 1
	Compressor 2
	Unit in Stand-by
	General Alarm
	High pressure Alarm
	Low pressure Alarm
	Anti-freeze electric heater activated
	Infrared Transmission activated
Flow!	Water Flow Alarm
	The display is showing a time value
	Compressor Maintenance Request
Menu	Function Menu activated

3. KEY FUNCTION

	<ol style="list-style-type: none"> 1. M to enter the function Menu or to set the clock
	<ol style="list-style-type: none"> 1. SET allows to show and modify the set point. 2. In programming mode it selects a parameter and confirm its value.
	<ol style="list-style-type: none"> 1. Depending on the programming, push it for 5 s to run the unit in Chiller or Heat Pump mode. 2. Push and release to change the read-out between "IN/OUT water" / supplied air. 3. In programming mode it scrolls the parameter list or and decreases the value of the parameter itself.
	<ol style="list-style-type: none"> 4. Depending on the programming, push it for 5 s to run the unit in Chiller or Heat Pump mode. 5. Push and release to change the read-out between "outside air" / defrost temp. 6. In programming mode it scrolls the parameter list or and decreases the value of the parameter itself.

3.1 Key Combination

	Enter the programming.
	Exit the programming.
	Push them together for more than 5 sec to start a manual defrost.

4. KEYBOARD LEDS

Symbol	Led	Function
	On	Heat pump
	On	Chiller
	Blinking	Programming phase (It blinks with led)
	Blinking	Time delay before defrosting
	On	Defrost On
	Off	Defrost Off
		Clock Set-up

5. REMOTE KEYBOARD VI610



5.1 Key Function

	M allows to enter the menu or to set the clock time.
	SET allows to show and modify the set point. During the programming it selects a parameter and confirm its value.
	It selects the water IN / OUT or the ambient air read-outs. During the programming it scrolls the parameter code or increases its value.

	It selects the external /defrost air temperature read-out. During the programming it scrolls the parameter code or decreases its value.
	If pushed for 5s it allows to start the unit in chiller or heat pump function.
	If pushed for 5s it allow to start the unit in chiller or heat pump function.

For Air/Air unit: using the remote keyboard with NTC sensor on board (VI610S model) and with the parameter CF35 = 2, the read-out and the regulation are controlled by the NTC sensor mounted on the remote keyboard. When the communication between the keyboard and the instrument is broken, the left upper side of the display will show "noL" (no link message).

6. NORMAL CONDITION READ-OUT



If no alarm conditions are present, the display shows:

Left upper side:

- Evaporator water Inlet/Outlet (Air/Water, Water/Water).
- Ambient / evaporator outlet temperatures (Air/Air).

Left lower side:

- Condensing Temperature / Pressure
- Anti-freeze evaporator water (Water/Water with Heat P.).
- The clock .

6.1 Alarm Read-Out



Starting from the normal condition (no alarms), when the instrument detects an alarm event, the left lower side shows the alarm code alternated with the probe value. The corresponding icon sligheted.

6.2 Icon Dedicated to the Alarm Read-Outs

The following four icons are dedicated to a better alarm understanding:



Generic Alarm



High pressure alarm



Low pressure alarm



Water flow Alarm

7. SILENCING THE BUZZER

Automatically: just after the alarm condition is recovered.

Manually: push and release one of the four keys; the buzzer is stopped even if the alarm is still active.

8. FIRST INSTALLING

After giving power supply to the instrument, the left lower display can show "rtC" alternated with the probe value: **it is necessary to set the clock time.**

If the probes are not connected, or they are faulty, the display shows the corresponding alarm code.

In any case it is possible to proceed with the parameter or clock setting.

9. HOW TO SET THE CLOCK RTC

1. Push the **M** key for some seconds and wait until the "Hour" label appears. Release the **M** key.
2. Now push **SET**: the hour value starts blinking.
3. Use the **▼** and **▲** to change the value. Confirm by pushing **SET**; After some seconds the controller will show the next parameter (Min).
4. Repeat the points 2 and 3 to set the other parameters:

Min: minutes (0÷60)

UdAy: day of the week (**Sun** = Sunday, **Mon** = Monday, **tuE** = Tuesday, **UEd** = Wednesday, **thU** = Thursday, **Fri** = Friday, **SAT** = Saturday).

dAy: day of the month(0÷31)

MntH: Month (1÷12)

yEA: Year (00÷99)

10. "HOT KEY" PROGRAMMING

10.1 Download from the Hot Key (previously programmed) to the Instrument Memory

The controller power supply is off:

- Insert The Hot Key.

- Turn the power supply on.
 - The download starts and lasts some seconds. During this phase the whole regulation is locked and the "dOL" message is blinking. When finishing the "End " message will appear if the programming result is good, after 15s the regulation automatically restarts
- If "Err" message appears the operation has given bad result. Turn the controller off and then on again to repeat the operation or restart the normal regulation.

10.2 Upload the Parameter from the Controller to the Hot Key

The instrument is on:

1. Insert the Hot Key.
2. Enter the function menu.
3. Select the **UPL** function with the arrow keys.
4. Push **SET** key. The Upload starts immediately from the instrument to the key memory.

During this phase the whole regulation is locked and the "UPL" message is blinking.

When finishing the "End " message will appear if the programming result is good, after 15s the regulation automatically restarts

If "Err" message appears the operation has given bad result. Repeat the points 1-4 for a new Upload.

11. KEYBOARD PROGRAMMING

To allow an easier identification of parameter meaning, the parameters of the controller have been collected in different families each one named with a peculiar label.

11.1 "Pr1" Programming Level (User Level)



To enter the "Pr1" User Level:

- 1) Push the **SET + ▼** key for some seconds (and Leeds start blinking) the upper display shows "ALL" that is the first family of parameters.
- 2) Using **▲** and **▼** arrows scroll the other family labels.
- 3) After finding the right one, push **SET** key to enter and see all the parameter belonging to that family, the display shows the first parameter label and its value.

Scroll the parameter list with **▲** and **▼** arrows or modify the value as described in 11.4.

11.2 "Pr2" Parameter Level (Factory Level)

The "Pr2" parameter level is accessible through password:

1. Reach "Pr1" as described in 11.1.
2. Select the parameter "Pr2", the "PAS" label appears on the upper side.
3. Push **SET**: the lower display shows **Pas** while the upper display **0** blinking.
4. Set the password using **▲** and **▼** keys.
5. Push **SET** key to confirm the value.

11.3 How to Move a Parameter from "Pr2" Level to "Pr1" Level.

Enter the "Pr2" level and select the parameter to move; keeping pressed the **SET** key push and immediately release the **▼** key. One of the nearest led will light to indicate the presence of the parameter in "Pr1". Then release also **SET** key.

To move the parameter in "Pr2" again: keep pressed **SET** key and immediately release the **▼** key. The led turns off so as the parameter is not more visible in "Pr1" but just in "Pr2".

11.4 To Change a Parameter Value

1. Access to programming mode Pr1 or Pr2
2. Select the parameter to change.
3. Push **SET** key to enable its value.
4. Modify the value with **▲** and **▼** keys.
5. Push **SET** key again to confirm the new value, after some seconds next parameter will be displayed.
6. Exit the programming: push **SET + ▲**, when a parameter label is displayed, or wait 15s (time-out) without pushing any keys.

NOTE: The new parameter value is also confirmed if, after changing it, no **SET** key is pressed for the time-out to exit.

12. CHANGE THE PASSWORD

Before modifying the password you must know the previous value. This operation is possible only under **Pr2**.

- 1) Enter **Pr1** level.
- 2) Select the family containing the interested parameters.
- 3) Push **SET** key.
- 4) Using arrows key select the parameter "Pr2", then push **SET** key. The lower display shows "PAS" while the upper side is **0** blinking.
- 5) Use **▼** and **▲** to set the active PASSWORD. push **SET** key to reach the **Pr2** level.
- 6) To modify the password: select the "Pr2" parameter.
- 7) Push **SET** key to enter the new value (blinking).
- 8) Insert the new password with **▲** and **▼** keys.
- 9) Push **SET** key to confirm it.
- 10) The upper display will blink for few seconds then, next parameter will be showed.
- 11) Exit the programming by pushing **SET + ▲** together or wait the time-out.

13. VALUE OF DISPLAY READ-OUT PAR. CF36

The parameter data can change depending on CF03 parameter value.

13.1 Parameter CF36 = 0

Upper display shows as default Pb1 probe.

Lower display: if CF06 =1,2,4, it shows Pb3 probe, if CF07=1,4 it shows Pb4 probe.

13.2 Parameter CF36 = 1

Upper display shows as default Pb2 probe.

Lower display: if CF06 =1,2,4, it shows Pb3 probe, if CF07=1,4, it shows Pb4 probe.

13.3 Parameter CF36 = 2

Upper display shows as default Pb1 probe.

Lower display shows the clock time.

13.4 Parameter CF36 = 3

Upper display shows **Pb2** probe.

Lower display shows the clock time.

If the default probe is **Pb1** value, each time the **▲** key is pressed the upper display shows **Pb2** value for 30 seconds with **OUT** label. When the time is expired, it comes back to default **Pb1** read-out.

If the default probe is **Pb2** value, each time the **▲** key is pressed the upper display shows **Pb1** value for 30 seconds with **IN** label. Then it comes back to default **Pb1** read-out.

13.5 Display Read-Out when Remote ON/OFF

The digital input configured as remote OFF: if activated it turns off the controller (also for motocondensing), upper display shows "OFF" the decimal point led is blinking.

1. This remote on/off command overrides the instrument keyboard commands.
2. The keyboard commands are active only when the digital input is not active.
3. When the remote off is not activated the controller automatically restarts.

13.6 Upper Display Read-Out with Par. CF02=1 (Motocondensing Unit)

Upper display shows:

"**ON**" with digital input active

"**OFF**" with digital input not active.

If the chiller function is selected it turns to **OnC**.

If the Heat Pump is selected it turns to **OnH**.

Even for the Motocondensing function the user is allowed to check the probe values using key arrows and to verify and manage the alarm events.

14. START / STOP CHILLER OR HEAT PUMP

By pressing  key for 5 seconds the unit starts or stops the Chiller cycle if the parameter **CF31 =0**, otherwise if parameter **CF31 =1**, it starts / stops in Heat Pump mode.

The  led blinks for 5 seconds then it turns on. To change from Chiller to HP or vice versa, it is necessary to stop the cycle and then restart the new.

By pressing  key for 5seconds, the unit starts or stops the Heat Pump cycle if parameter **CF31 =0**, otherwise, if parameter **CF31 =1**, it starts / stops in Chiller mode.

The  led blinks for 5 seconds then it turns on. To change from Chiller to HP or vice-versa, it is necessary to stop the cycle and then restart the new.

15. STAND-BY FUNCTION

Each time the Chiller or Heat Pump cycles are stopped, the unit goes in stand-by and the  icon turns on. The controller stand-by allows to:

- Show the probe values using key arrows.
- Show and manage the alarm events.

16. "M KEY" THE FUNCTION MENU

Entering the function Menu allows to:

1. Show and reset the active alarms.
2. Show and reset the time running hour counters of the loads.
3. Enable the infra-red communication device.
4. Show the time delay to achieve and start the defrost (only for Heat Pump).
5. Upload the parameters from the controller to the Hot Key (see 10.2).
6. Show the alarm log.
7. Reset the alarm log.

During the Menu operations the "menu" icon is on.

16.1 Access to Function Menu





Push and release the **M** key. The "menu" icon is on.

16.2 Exit from function Menu

Push and release the **M** key or wait the time out. The "menu" icon disappears.





16.3 How to Show the Alarm Events

Enter the function Menu:

1. Use  or  keys to find the "ALrM" label.
2. Push and release the **SET** key.
3. Use  or  keys to scroll the alarm list.



To exit the function Menu push and release the **M** key or wait the time-out. The "menu" icon disappears.

16.4 How to Reset an Alarm Event

- 1) Enter the function Menu.
- 2) Use  or  keys to find the "ALrM" label.
- 3) Push and release the **SET** key, the lower display shows the alarm code.
- 4) Upper display: **rSt** label if the alarm can be reset, **NO** label if it is not possible.
Use  or  keys to scroll the alarm list.
- 5) Push **SET** key, when **rSt** is lighted, to reset the alarm, after a while the read-out move to next alarm.
- 6) To exit the function menu push and release the **M** key or wait the time-out. The "menu" icon disappears.

16.5 Time Running Hour Counter of the Loads

Enter the function Menu.



Use  or  keys to find on the lower display:

- **C1Hr** (Compressor n°1 hour counter),
- **C2Hr** (Compressor n°2 hour counter),
- **PFHr** (Water pump or supply fan hour counter).



The upper display shows the time running hour value.

The clock icon  is lighted.



16.6 Reset the Hour Counters

1. Enter the function Menu.
2. Use  or  keys to find on the lower display the **C1Hr**, **C2Hr** or **PFHr**.
3. Push **SET** key for 3seconds: the upper display turns to 0 indicating the reset.
4. To exit the function menu push and release the **M** key or wait the time-out. The "menu" icon disappears.

16.7 Show the Time Delay to Start the Defrost

1. Enter the function Menu.
2. Use  or  keys to find, on the upper display, the **dEF** (defrost) label, the lower display shows the time delay to reach and start the defrost (minutes and seconds), the icon  is blinking.
3. To exit the function menu push and release the **M** key or wait the time-out. The "menu" icon disappears.

16.8 Infrared Transmission Procedure

1. Enter the function Menu.
2. Use  or  keys to find, on the lower display, the "Ir" label while, the upper display shows label **ALr** = ALARM ;
Par = PARAMETER;
LOG = RECORDED DATA.
3. Push and release **SET** key.

4. If the password is active enter its value.
5. The infrared icon **IR** is now lighted. The controller starts sending the data. **You have 1 minute to place the IR receiver device in front of the instrument.**
6. On the receiver, push **RX** key to enable the receiving: the **RX** led blinks during the interlacing procedure. During the data transferring the **RX** is lighted, it turns off to signal the end of the procedure.
7. To exit the function menu push and release the **M** key or wait the time-out. The "menu" icon disappears.

16.9 How to See the Alarm Log

1. Enter the function Menu.
2. Use **▲** or **▼** keys to find **ALOG** label.
3. Push **SET** key: the lower display shows the alarm code, the upper display shows "n" followed by the progressive number.
4. With **▲** or **▼** scroll the alarm list.
5. To exit from **ALOG** function push **M** key or wait the time-out delay is expired.

The memory contains **50** alarm events structured in a FIFO list. Each new alarm will take the place of the oldest alarm contained in the FIFO list. (the read-out is ordered from the oldest to the newest)

16.10 How to Reset the Alarm Log

- 1) Enter the function Menu.
- 2) Select the **ALOG** label showed on the lower display.
- 3) Push **SET** key.
- 4) Select with **▲** or **▼** keys the **ArSt** (Alarm reset) label on the lower display, the upper display is **PAS**.
- 5) Push **SET** key and then enter the password **PAS**, upper display shows **0** blinking.
- 6) Write the right password number.
- 7) The **ArSt** label starts blinking for **5s**, to confirm the alarm logging data is reset.

After finishing the display restarts from normal condition.

17. KEYBOARD FUNCTIONS

17.1 How to See the Set Point Value

Push and release the **SET** key.

Lower display shows: **SetC** set of chiller mode;
SetH set of heat pump mode.

The upper display shows the corresponding set value.
(SetH is available only if configured for Heat Pump).

17.2 How to Change the Set Point Value

- 1) Push **SET** key for more than **3** seconds.
- 2) The setpoint value is now blinking.
- 3) Use **▲** and **▼** to increase or decrease the new value.

When finishing, push and release **SET** key again or wait for the time-out to exit the programming.

17.3 How to See the Set Point with Energy Saving or Dynamic Set Functions Enabled

When working in Chiller or Heat Pump, the first time **SET** key is pushed the lower display shows **SetC** (set chiller); or **SetH** (set heat pump) and the upper shows its value.

When the "Energy Saving" is activated, by pressing **SET** key again, the lower display shows "**SetS**" (set saving) while the upper display will turn to the real setpoint value used to control the unit during this function.

When working with "Dynamic Set", by pushing **SET** again, the lower display shows "**SetD**" (set dynamic), while the upper display will turn to the real setpoint value used to control the unit during this function.

The **SetS** or **SetD** appears only if the corresponding functions are activated.

18. HOW TO TURN A COMPRESSOR IN OFF-LINE

A compressor can be turned off for maintenance or if it is in bad condition, without interfering with the normal cycle of the unit. Therefore, it is not necessary to stop the unit or the cycle.

1. Access the programming mode.
2. Find and then set the parameter **CO12 = 1** (compressor 1 = OFF: out of the process control).
3. If necessary find and then set also the parameter **CO13 = 1** (2ndcomp. / step 1stcomp.= OFF).

To restore the compressor in the process control set the **CO12** and/or **CO13** parameter = 0.

19. DYNAMIC SET POINT

This function is useful to save energy or to run the unit with particular external air temperature condition. It allows to increase or reduce the setpoint with a positive or negative proportional offset. This value is combined with parameters **Sd02** (for Chiller) or **Sd03** (for HP), the 4..20mA analogue input or the outside air temperature.

The Dynamic Set is enabled if:

- The parameters **Sd01 = 1** and **CF06 = 3**, Pb3 probe configured as 4..20mA signal;

- The parameter **Sd01 = 1** and **CF07 = 3**, Pb4 probe configured as outside air temperature. If the parameter **CF07=3**, by pushing and releasing the **▼** key the upper display shows for **30** seconds the outside air temperature while the lower display shows **Et** (external temperature) label.

Pb3 probe configured as 4..20mA input signal (below)

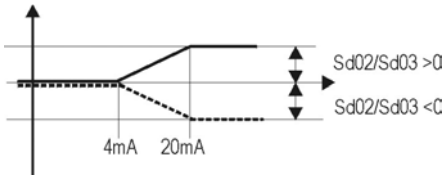

Pb4 probe with positive differential (below)

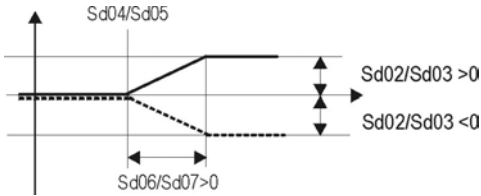

Pb4 probe with negative differential (below)

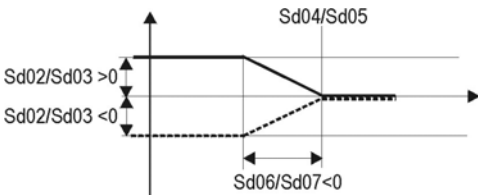

20. ENERGY SAVING

It is daily or weekly configurable function with "hour time table" (if RTC on board) or depending from external digital input. During the Energy Saving cycle the real setpoint is calculated with the parameters ES10 and ES12: **SET+ES10** for chiller, **SET+ES12** for Heat Pump.

The differential for the function cut-in/out is depending by **ES11** for Chiller and **ES13** for Heat Pump.

20.1 Daily Programming

The daily programming is based on 7 parameters **ES03->ES09** corresponding to the 7 days of the week; the value 1 enable the function for that day.

Eg: **ES03 = 1** means that the Energy Saving is activated for the whole 24 hours on Monday. If needed, repeat the operation for the whole week ES04(Tue)..ES09(Sun).

20.2 Hour Time Table (with RTC)

Based on two parameters: ES01 Energy Saving start hour and **ES02** Energy Saving stop hour.

Eg: **ES01 = 8.0** and **ES02 = 10.0** it means that the Energy Saving is active from 8 to 10.0 for all the days of the week.

Eg: **ES01 = 23.0** and **ES02 = 8.0** it means that the Energy Saving is active from 23.0 to 8.0 of the next morning; for all the days of the week. This function is disabled if the parameters ES01 / ES02 are both 0.

20.3 Energy Saving with External Contact

The function is enabled when the digital input, configured as Energy Saving, is activated by remote contact.

21. COMPRESSOR FUNCTIONING

21.1 Compressor Control in Chiller Mode

Parameter **CF21=0,3** (1 Compressor selected)

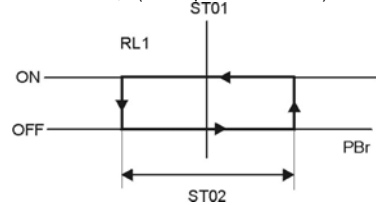

Parameter **CF21=1** (1 compressor with step)

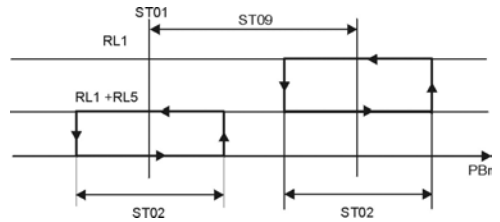

Parameter **CF21=2** (2 compressor)

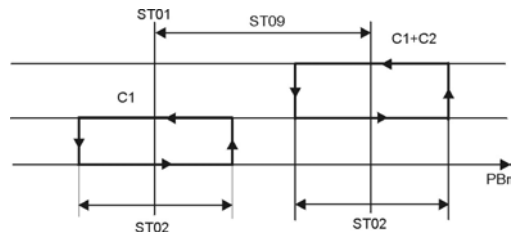

21.2 Compressor Regulation for Heat Pump

Parameter CF21=0,3 (1 compressor)

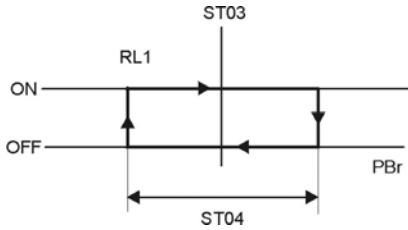

Parameter CF21=1 (1 compressor with step)

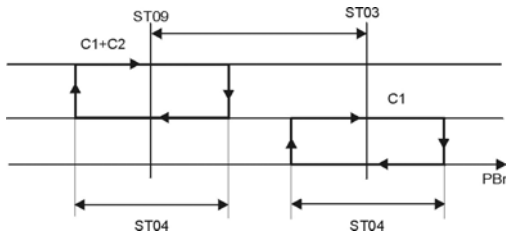

Parameter CF21=2 (2 compressors)

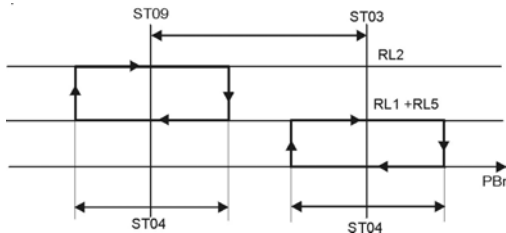

22. CONDENSER FAN REGULATION

22.1 ON/OFF Fan in Chiller Mode

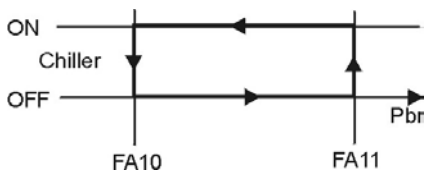

22.2 ON/OFF Fan in Heat Pump

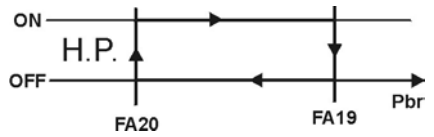

22.3 Triac or 4..20mA Output in Chiller Mode

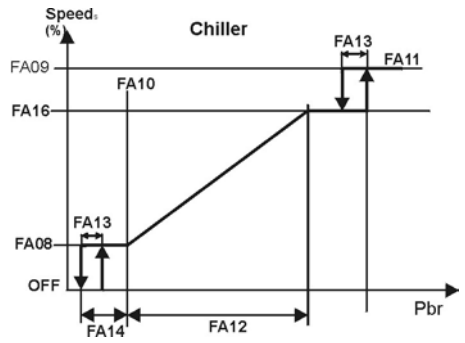

22.4 Triac or 4..20mA Output in Heat Pump

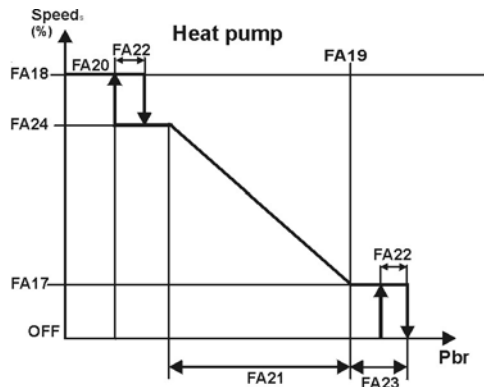

23. HOT START FUNCTION

Available only if the parameter CF01=1 air/air unit configured as heat pump, it allows to start the supply air fan only if the temperature of the condenser side is enough hot. This avoid to push cold air flow into the ambient.

23.1 Hot Start Fan Graphic Function

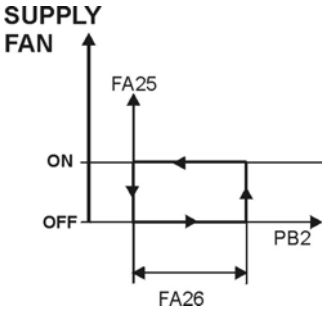

FA25 Set point of the Hot Start

Set the temperature value, detected by the **Pb2** probe, under which the fan is keep locked.

FA26 Differential of the Hot Start

Set the differential to regulate the fan ON/OFF.

24. AUTOMATIC CHANGE - OVER

It automatic changes the chiller <-> heat pump functioning of the unit in correlation with the external temperature condition.

The changing occurs only when the following condition are satisfied, otherwise the **unit turns to stand-by**:

1. **CF01=1,3,5,7** (Heat Pump selected).
2. **CF28=2** and **CF07=3** (**Pb4** external air temperature).
3. **Pb4** probe is not faulty.

The Change Over function is regulated by parameters:

CF29 is the set point and it represents the **Pb4** value under which the controller turns to Heat Pump mode.

CF30 represents the temperature differential to turns to Chiller mode.

The user can find helpful information by pushing and releasing **▼** key so as the upper display shows the **Pb4** value while the lower display shows **Et** label.

24.1 Graph Regulation of the Change-Over

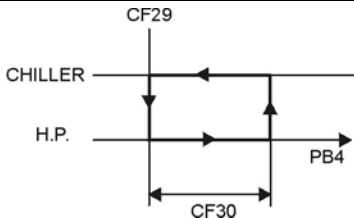

When the temperature value is within the **CF30** range, the changeover is allowed only though keyboard.

25. DEFROST FUNCTION

The defrost cycle is enabled only if the following condition are satisfied:

1. CF01=1,3,7 configuration chiller unit with heat pump.
2. dF01=1 defrost cycle enabled.
3. CF20=0 relay n°4 configured as reversing valve.
4. The unit is working in heat pump mode.
5. Pb3 or Pb4 must be configured as control condensing probe without active faulty probe alarms.

If only one of these conditions is not satisfied the defrost does not operate.

25.1 Forced Defrost

This function is enabled only if dF05 <> 0 and allows to operate a defrost even during the counting of the time delay dF10 and if the temperature/pressure value lower than the parameter dF19 value for the dF05 time value.

If during the time delay dF05 the temperature/pressure becomes higher than the parameters dF1+dF20 (differential) value then the whole procedure is stopped and the time delay dF05 will be reloaded.

25.2 Combined Defrost

This function is enabled only if CF07 = 5 and with Pb4 configured as NTC probe therefore it is used for external temperature on the evaporator coil during the heat pump mode. The detected temperature allows to calculate a better defrost cycle giving the start and the end commands for the cycle itself. Functioning:

The Pb3 probe gives the input signal, to start the time delay counting, when its value is lower than dF03 parameter. After the delay dF10 the controller check Pb4 value: if lower than dF11 the defrost procedure starts otherwise the unit still works in Heat Pump. Just after the temperature decreases under dF11 the defrost is enabled. The combined defrost stops just when Pb4 probe value reaches the end defrost temperature in dF12. If the combined defrost is enabled is possible through key, to see the external temperature showed on the upper display for **30** seconds while the lower display shows **dEF** label.

25.3 Manual Defrost

The unit is working with 1 or 2 compressor running.

The start defrost temperature/pressure value must be lower than dF03.

If the "combined defrost" is enabled, Pb4 value must be lower than dF11.

If the above conditions are satisfied, by pushing **SET + ▲** for more than **5s** the defrost cycle immediately starts.

26. RELAY CONFIGURATION

Relay n° 1 = Compressor 1

Relay n° 2-3 automatically change their configuration depending on the unit configuration.

Relay n° 2 = Anti-freeze heater CF01 = 2-3-4-5; integration heater with CF01 = 0 - 1

Relay n° 3 = Water pump, with CF01 = 2-3-4-5; supply air fan CF01 = 0 -1

Relay	Value of par.CF20			
	0	1		
°n 4	Inversing valve	Fan ON/OFF		
Relay	Value of par.CF21			
	0	1	2	3
°n 5	Alarm	Stage of the 1 st compressor.	2 nd compressor	Fan ON/OFF

When working with one compressor with one stage valve: the relay n°5 is configured as stage valve **CF21=1**: the polarity of the stage valve is determined by **CO10**.

CO10 = 0	RL1 comp.	RL5 parz.
No call	OFF	OFF
Compressor call	ON	OFF
1 st Stage call	ON	ON
CO10 = 1	RL1 comp.	RL5 parz.
No call	OFF	ON
Compressor call	ON	ON
1 st Stage call	ON	OFF

27. DATA LOGGER

The data recording is enabled if the log time **LG08 > 0**.

The recordable data can be included enabling the **LG01** to **LG07** parameters.

28. BOILER FUNCTION

The electric heater can be activated as heating integration control **Ar20=0** or heating control **Ar20=1** during the heat pump functioning mode.

It is enabled only if:

- Unit configured in Heat Pump mode CF01=3-5.
- Pb4 configured as external air probe CF07=3.

28.1 Heating Integration Control Ar20=0

The Boiler function starts when the Pb4 probe value decreases under Ar21 value.

If the water temperature detected by the regulation probe is lower than the ST03 parameter, the electric resistance heater is activated. The on/off algorithm of the electric resistance heater is the same as the compressor control with Heat Pump mode.

If the external air temperature becomes higher than Ar21 + Ar22 (differential), the integration function stops working and the unit restarts (or still work) with Heat Pump mode.

28.2 Heating Control Ar20=1

The Boiler function begins when the Pb4 probe decreases under Ar21 value. When the delay is expired, if the water temperature detected by the regulation probe is lower than the ST03 parameter, the compressors are stopped while the electric resistance heater is activated. The on/off algorithm of the electric resistance heater is the same as the compressor control with Heat Pump mode.

If the external air temperature becomes higher than Ar21 + Ar22 (differential), the Boiler functions stops working and the unit restarts with Heat Pump mode, compressors and fans restart working.

29. MAINTENANCE FUNCTION

CO14 for 1st compressor, **CO15** for 2nd compressor and **CO16** for water pump or supplied air fan (air/air) are the maximum time running hours to signal a maintenance request, the icon  is blinking. The icon only indicates the need of a check: **nothing else happens**. It stops blinking just after resetting the hour counter under the function Menu.

30. BLACK OUT

After a black-out:

1. The controller restarts from the pervious status.
2. The defrost cycle is stopped.
3. All the working time delay will be reloaded.

31. INSTALLING AND MOUNTING

31.1 "C" Format (32*74mm)

The instrument shall be mounted on panel, in a 29x71 mm hole, and fixed using the special bracket supplied.

To obtain an IP65 protection grade use the front panel rubber gasket (mod. RG-C) as shown in figure 1.

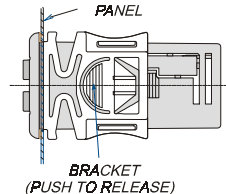

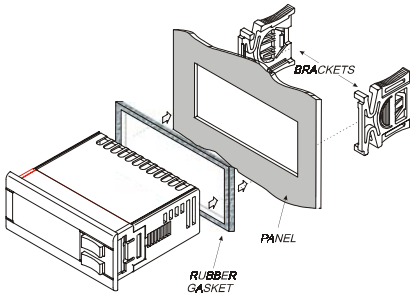
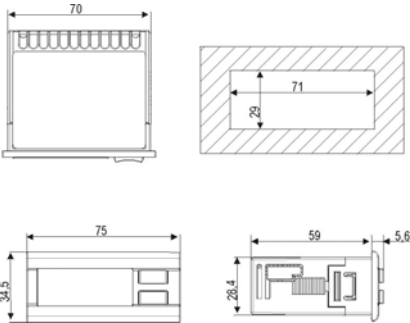
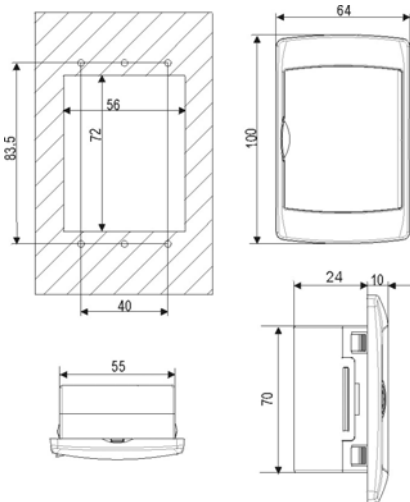

Fig. 1



31.2 "V" Format



Remote terminal "Vertical" shape
 Mounted on a panel with 72x56 mm cut-out, fixed with screw.

To obtain the IP65 protection, even for the panel, use the rubber gasket RGW-V (optional). For wall mounting use the V-KIT plastic adapter as illustrated in figure 2.

Fig. 2

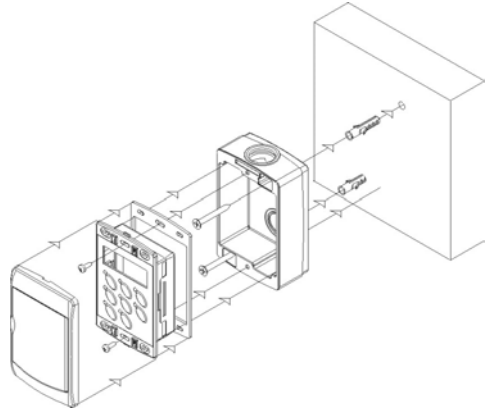

The temperature range allowed for correct operation is $-10\pm 60^{\circ}\text{C}$. Avoid places subject to strong vibrations, corrosive gases, excessive dirt or humidity. The same recommendations apply to probes. Let air circulate by the cooling holes.

32. ELECTRICAL WIRING

The controller is provided with removable terminal blocks for wires having section not bigger than 1.0 mm²:

- 14 ways for analogue and digital inputs,
- 12 ways for relays

Note: terminals 17-19 are connected inside the controller, they are the common for the "relay n°1" with terminal 15 and "relay n°2" with terminal 16

Terminals 21-22 are connected inside the controller, they are the common for the "relay n°3" with terminal 18 and "relay n°4" with terminal 20.

A 5-ways connector is dedicated to the TTL / RS485 interface.

Four connectors having 2-way for 0.2 mm² wires are dedicated to: remote terminal, 12Vdc open collector alarm, Pb4 probe, 4..20mA analogue output.

Remote terminal is provided with 2-ways screw terminal block for wires not bigger than 2.5 mm². **Check power supply data before connection wires. Keep the probe and the digital input wires separate from the power cable.** Do not exceed the maximum rating current for each relay, check technical data and if the load is bigger, use filtered contactors.

33. ALARM CODE AND EVENTS

Cod	Meaning	Cause / Origin	Instrument behaviour	Reset
P1	Pb1 probe alarm	Missing, faulty probe or resistance exceeding value	Open collector / alarm relay ON Buzzer ON General alarm icon lighted Alarm code on display	Automatic if the probe value recovers
P2	Pb2 probe alarm	Missing, faulty probe or resistance exceeding value	Open collector / alarm relay ON Buzzer ON General alarm icon lighted Alarm code on display	Automatic if the probe value recovers
P3	Pb3 probe alarm	Missing, faulty probe or resistance /current exceeding value	Open collector / alarm relay ON Buzzer ON General alarm icon lighted Alarm code on display	Automatic if the probe value recovers
P4	Pb4 probe alarm	Missing, faulty probe or resistance exceeding value	Open collector / alarm relay ON Buzzer ON General alarm icon lighted Alarm code on display	Automatic if the probe value recovers
A01	High pressure switch alarm	Digital input for high pressure activated	Open collector / alarm relay ON Buzzer ON High pressure icon lighted Alarm code on display	Manual: after the alarm event expires, proceed with manual reset.
A02	Low pressure switch alarm	Digital input for low pressure activated	Open collector / alarm relay ON Buzzer ON Low pressure icon lighted Alarm code on display	Automatic. It turns to manual after AL02 events in 1 hour. Manual: after the alarm event expires, proceed with manual reset.
A03	Low temperature alarm of the supplied temperature	Digital input active if CF01=0,1 and Pb1 < AR03 for AR05 seconds.	Open collector / alarm relay ON Buzzer ON General alarm icon lighted Alarm code on display	Automatic: when Pb1 value increases over AR03+AR04 value.
A04	Low temperature alarm of the outlet air from evaporator.	Digital input active if CF01=0,1 and Pb2 < AR03 for AR05 seconds	Open collector / alarm relay ON Buzzer ON General alarm icon lighted Alarm code on display	Automatic. It turns to manual after Ar06 events in 1 hour. Manual: the event expires if Pb2 > (AR03+ AR04), then proceed with manual reset.
A05	High temperature High pressure	Digital input active Pb3 o Pb4 > AL11	Open collector / alarm relay ON Buzzer ON High alarm icon lighted Alarm code on display	Manual: the event expires if Pb3 or Pb4 < (AL11-AL12), then proceed with manual reset.
A06	Low temperature Low pressure	Digital input active Pb3 o Pb4 < AL14	Open collector / alarm relay ON Buzzer ON Low alarm icon lighted Alarm code on display	Automatic. It turns to manual after AL06 events in 1 hour. Manual: the event expires if Pb3 or Pb4 > (AL14+AL15), then proceed with manual reset.

A07	Anti freeze alarm	Digital input active anti freeze probe Pbr < AR03 for minimum AR05 seconds	Open collector / alarm relay ON Buzzer ON General alarm icon lighted Alarm code on display	Automatic. It turns to manual after Ar06 events in 1 hour. Manual: the event expires if Pbr > (AR03+AR04), then proceed with manual reset.
A07	Anti freeze alarm motocondensing unit	Digital input active CF01=6,7 and CF05=2	Open collector / alarm relay ON Buzzer ON General alarm icon lighted Alarm code on display	Automatic. It turns to manual Ar06 events in 1 hour. Manual: the event expires, then proceed with manual reset.
A08	Water flow alarm (air/water water/water; Supply air fan thermal protection (air/air)	Digital input active for AL06 duration.	Open collector / alarm relay ON Buzzer ON Flow alarm icon lighted Alarm code on display	Automatic. It turns to manual after Ar05 events in 1 hour. Manual: the event expires for AL07, then proceed with manual reset.
A09	Compressor 1 thermal protection alarm	Digital input active	Open collector / alarm relay ON Buzzer ON General alarm icon lighted Alarm code on display	Manual: the event expires, then proceed with manual reset. After AL09 events in 1 hour and digital input not active, set AL10=0 to resume.
A10	Compressor 2 thermal protection alarm	Digital input active	Open collector / alarm relay ON Buzzer ON General alarm icon lighted Alarm code on display	Manual: the event expires, then proceed with manual reset. After AL09 events in 1 hour and digital input not active, set AL10=0 to resume.
A11	Condenser fan thermal protection alarm	Digital input active	Open collector / alarm relay ON Buzzer ON General alarm icon lighted Alarm code on display	Manual: the event expires, then proceed with manual reset.
A12	Defrost error alarm	End defrost after dF07 (Max defrost length) with dF02=2	Only alarm code on display	Automatic: with next proper defrost cycle. Proceed with manual reset.
A13	Compressor 1 maintenance warning	Running hour > CO14	Open collector / alarm relay ON Buzzer ON Maintenance icon lighted Alarm code on display	Manual: Proceed with the hour reset procedure 16.6
A14	Compressor 2 maintenance warning	Running hour > CO15	Open collector / alarm relay ON Buzzer ON Maintenance icon lighted Alarm code on display	Manual: Proceed with the hour reset procedure 16.6

A15	Water pump or supply air fan (air/air) maint. Warning	Running hour > CO16	Open collector / alarm relay ON Buzzer ON Maintenance icon lighted Alarm code on display	Manual: Proceed with the hour reset procedure 16.6
rtC	Clock alarm	Need to set the clock time	Open collector / alarm relay ON Buzzer ON General alarm icon lighted Alarm code on display	Manual: Set the clock and then proceed with manual reset.
rtF	Clock alarm	Faulty clock control	Open collector / alarm relay ON Buzzer ON General alarm icon lighted Alarm code on display	Manual: Proceed with manual reset, if nothing happens change the clock.
EE	EEPROM error alarm	Possible data losing	Open collector / alarm relay ON Buzzer ON General alarm icon lighted Alarm code on display	Manual: Proceed with manual reset., if nothing happens the controller is locked, no regulation available.
ACF1	Configuration alarm	Heat pump configured without reversing valve	Open collector / alarm relay ON Buzzer ON General alarm icon lighted Alarm code on display	Automatic After parameter proper debug.
ACF2	Configuration alarm	CF01= 0-1-2-3 and FA02 =1-2, without condensing probe control configuration	Open collector / alarm relay ON Buzzer ON General alarm icon lighted Alarm code on display	Automatic After parameter proper debug.
ACF3	Configuration alarm	Two digital inputs having the same function	Open collector / alarm relay ON Buzzer ON General alarm icon lighted Alarm code on display	Automatic After parameter proper debug.
ACF4	Configuration alarm	CF28= 1 & digital input not configured or CF28= 2 probe Pb4 <> 3	Open collector / alarm relay ON Buzzer ON General alarm icon lighted Alarm code on display	Automatic After parameter proper debug.
ACF5	Configuration alarm	CF02 =1 & (CF04 ≠2,3 & CF05 ≠ 3) or (CF04 = 2 and CF05 = 3)	Open collector / alarm relay ON Buzzer ON General alarm icon lighted Alarm code on display	Automatic After parameter proper debug.
FErr	Functioning alarm	CF04=3 and CF05=3 With digital input activated at the same time	Open collector / alarm relay ON Buzzer ON General alarm icon lighted Alarm code on display	Manual: after the alarm event expires, proceed with manual reset.
AFr	Frequency alarm	The frequency of power supply is out of range	Open collector / alarm relay ON Buzzer ON General alarm icon lighted Alarm code on display	Automatic After the frequency becomes normal

34. OUTPUT LOCK FOR ALARM EVENT TABLE

Alarm Code	Alarm Description	Comp. 1	Comp. 2	Anti - freeze Heater	Water Pump	Supply air fan	Cond. fan
P1	Pb1 Probe Alarm	Yes	Yes	Yes with Ar19 =0			Yes
P2	Pb2 Probe Alarm	Yes	Yes	Yes with Ar19 =0			Yes
P3	Pb3 Probe Alarm	Yes	Yes	Yes with Ar19 =0			Yes
P4	Pb4 Probe Alarm	Yes	Yes	Yes with Ar19 =0			Yes
A01	High pressure alarm from digital input	Yes	Yes				
A02	Low pressure alarm from digital input	Yes	Yes				Yes
A03	Low temperature alarm of supplied air						
A04	Low temperature outlet air	Yes	Yes	Yes		Yes	
A05	High temperature / high pressure alarm	Yes	Yes				
A06	Low temperature / low pressure alarm	Yes	Yes				Yes
A07	Anti freezer digital input	Yes	Yes				Yes
A07	Anti-freeze digital input alarm	Yes	Yes				Yes
A07	Anti-freeze alarm motocondensing unit	Yes	Yes			Yes	Yes
A08	Water flow Alarm	Yes	Yes	Heater - boiler Yes	Yes		
A08	Supply air fan thermal protection CF01= 0, 1	Yes	Yes	Integration heater Yes		Yes	
A09	Compressor 1 thermal protection	Yes					
A10	Compressor 2 thermal protection		Yes				
A11	Condenser fan thermal protection	Yes	Yes				Yes
A12	Defrost error						
A13	Compressor 1 maintenance						
A14	Compressor 2 maintenance						
A15	Water pump / supply air fan maintenance						
rtC	Clock alarm						
rtF	Clock alarm						
EE	Eeprom error	Yes	Yes	Yes	Yes	Yes	Yes
ACF1	Configuration alarm	Yes	Yes	Yes	Yes	Yes	Yes
ACF2	Configuration alarm	Yes	Yes	Yes	Yes	Yes	Yes
ACF3	Configuration alarm	Yes	Yes	Yes	Yes	Yes	Yes
ACF4	Configuration alarm	Yes	Yes	Yes	Yes	Yes	Yes
ACF5	Configuration alarm	Yes	Yes	Yes	Yes	Yes	Yes
FErr	Functioning error (motocond.)	Yes	Yes		Yes	Yes	Yes
AFr	Frequency alarm	Yes	Yes	Yes	Yes	Yes	Yes

35. CONNECTING DIAGRAM

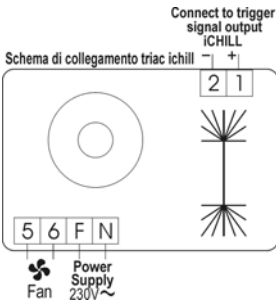
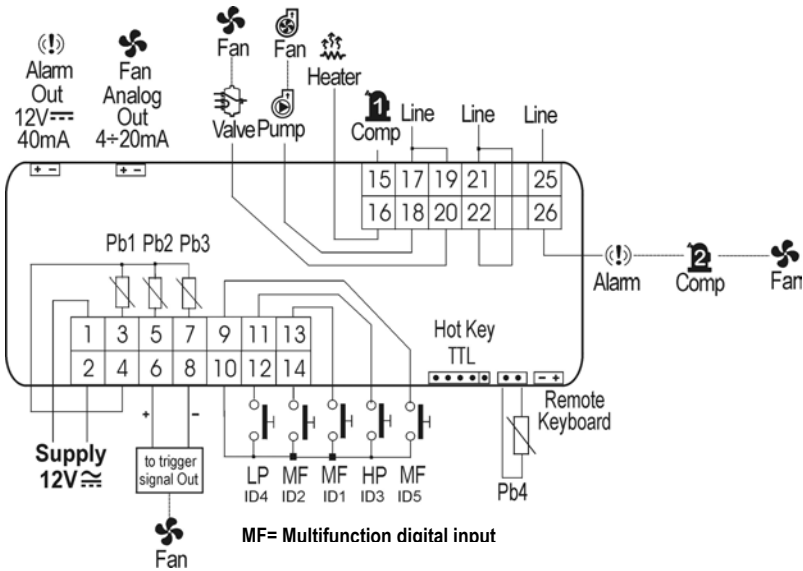

“C” Format or 32*74 mm shape remote



Vertical shape remote terminal

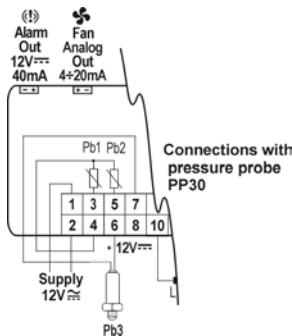
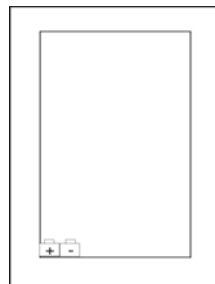

36. PARAMETER DESCRIPTION

36.1 Regulation Parameters

- ST01** Setpoint in Chiller mode(range ST05..ST06).
ST02 Differential of the Chiller mode.
ST03 Setpoint in Heat Pump mode (range ST07..ST08)
ST04 Differential of the Heat Pump mode.
ST05 Minimum limit value of ST01 settable for Chiller mode (range -40°C / °F...ST01).
ST06 Maximum limit value of ST01 settable for Chiller mode (range ST01...110 °C / 230°F).
ST07 Minimum limit value of ST03 settable for Heat Pump mode (range -40°C / °F...ST03).
ST08 Maximum limit value of ST03 settable for Heat Pump mode (range ST03...110 °C / 230°F).
ST09 Regulation band

36.2 Configuration parameters

- CF01** configure the type of the unit. Based on this parameter some parameters can be hidden. (see the table - menu)
 Type of unit:
 0= Chiller air / air
 1= Chiller air / air with heat pump
 2= Chiller air / water
 3= Chiller air / water with heat pump
 4= Chiller water / water
 5= Chiller water / water with heat pump
CF02 Motocondensing Unit
 0= Yes; 1= No
CF03 Regulation probe
 0= Pb1 probe control; 1= Pb2 probe control
CF04 Pb1 analogue input configuration:
 0 = No Probe
 1 = NTC probe for evaporator water inlet / controlled air showed on the upper display.
 2 = Digital input for Motocondensing unit.
 When the contact is not active the unit turns to stand-by, upper display shows OFF.
 The active input turns the unit in stand-by but the upper display shows ON.
 In this situation using ▲ and ▼ keys is possible to start the functioning in Chiller or Heat Pump mode:
 in Chiller mode the upper display shows OnC. If CF21=2 and CO08=1 the 1st compressor starts, with CF21=2 and CO08=0 the compressor with less counted hours starts.
 in Heat Pump mode the upper display shows OnH.: with CF21=2 and CO08=1 the 1st compressor starts, with CF21=2 and CO08=0 the compressor with less counted hours starts.

If the digital input becomes not active and then active again the unit stops and then restarts with the selected mode. Only with active input is possible to change the functioning again through ▲ and ▼ keys.

3 = Digital input for motocondensing unit. It turns the unit on only in Chiller mode, the upper display shows OnC. If the contact is not active the unit turns to stand-by and the display shows OFF. Only with active contact, if the unit has been turned off through ▲ and ▼ keys, is possible to turn it on again through ▲ and ▼ keys.

CF05 Pb2 input configuration

0 = no Probe

1 = NTC probe temperature "evaporator water outlet"/ "evaporator out air", it is showed on the upper display.
 2 = Digital input to generate the anti-freeze alarm, check the polarity.

3 = Digital input for motocondensing. If active it starts the unit in Heat Pump, the upper display shows OnH. While, if not active, the unit is in stand-by, the upper display shows OFF. Only if this input is active is possible to turn Off and On the unit through ▲ and ▼ keys.

CF06 Pb3 input configuration

0 = no Probe

1 = NTC temperature probe to control the condenser fan speed, it is showed on the lower display.

2 = 4..20mA condensing pressure input to control the condenser fan speed, it is showed on the lower display.

3 = 4..20mA Dynamic Setpoint input signal decided by the user.

4 = NTC condenser probe anti-freeze alarm (water/ water or water/water with Heat Pump) , it is showed on the lower display.

CF07 Pb4 input configuration

0 = no Probe

1 = NTC temperature probe to control the condenser fan speed, it is showed on the lower display.

2 = Configurable digital input.

3 = NTC probe for outdoor air control. It works for: Dynamic Setpoint, Boiler and Auto Change-over.

4 = NTC probe for condenser anti-freeze alarm (water/ water or water/water with Heat Pump), It is showed on the lower display.

5= NTC probe to detect the evaporator temperature in Heat Pump and control the Combined Defrost. It determines the defrost start and stop.

6= NTC probe used only for the data logger function.

CF08 Digital input configuration **ID1**

CF09 Digital input configuration **ID2**

CF10 Digital input configuration **ID5**

CF11 determines the functions of **Pb4** when configured as digital input:

0= If active it generates a compressor 1 thermal protection alarm.

1= If active it generates a condenser fan thermal protection alarm.

2= If active it generates a supply air fan (air/air) / water flow (water/air, water/water) thermal protection alarm.

3= If active it generates a remote OFF command. The instrument keyboard works only if the input is not active.

4= Remote "Chiller / Heat Pump" command. The instrument keyboard can start the unit only with the operating mode selected by remote. (See **CF28 = 1**).

5= If active it generates a 2nd compressor thermal protection alarm.

6= External call for 2nd compressor / stage (**Motocondensing**).

7 = If active it determines the end defrost cycle.

8 = If active it enables the Energy Saving function.

9 = If active it generates an "Anti ice alarm".

ID3 = If active it generates the high pressure alarm.

ID4 = If active it generates the high pressure alarm.

CF12 Digital input polarity **ID1**

CF13 Digital input polarity **ID2**

CF14 Digital input polarity **ID3**

CF15 Digital input polarity **ID4**

CF16 Digital input polarity **ID5**

CF17 Input polarity of **Pb1** when set as digital input.

CF18 Input polarity of **Pb2** when set as digital input.

CF19 Input polarity of **Pb4** when set as digital input.

0 = Input active for closed contact.

1 = Input active for open contact.

CF20 Configuration of the relay n°4.

0 = Inverting valve;

1 = Condenser fan.

The output polarity of the relay n°4 if **CF20 = 0** is defined by the parameter **dF18**.

CF21 Configuration of the relay n°5.

0 = Alarm relay;

1 = One Compressor with 1 stage;

2 = Two Compressors;

3 = Condenser fan.

Note rele' n°5 output polarity.

If **CF21 = 0** the output polarity is defined by par. **AL18**.

If **CF21 = 1** the stage valve polarity is defined by par. **CO10**.

CF22 Corresponding pressure value at 4mA of **Pb3**.

CF23 Corresponding pressure value at 20mA of **Pb3**.

CF24 Offset of **Pb1** probe to calibrate the read-out.

CF25 Offset of **Pb2** probe to calibrate the read-out.

CF26 Offset of **Pb3** probe to calibrate the read-out.

CF27 Offset of **Pb4** probe to calibrate the read-out.

CF28 It determines which command has the priority to turn the unit in Chiller or Heat Pump.

CF28 = 0 Keyboard commands override the digital input commands (see cap 12).

CF28 = 1 Digital input with priority control commands. It is enabled only when one of the digital inputs is configured to change the function "Chiller / Heat Pump" of the unit.

If the polarity of that digital input is **0**:

- Open contact means Chiller functioning.

- Closed contact means Heat Pump functioning.

If the polarity of that digital input is **0**:

- Open contact means Heat Pump functioning

- Closed contact means Chiller functioning.

If none of the digital inputs is set to 4, the **unit turns to stand-by**. The keyboard selection is disabled and the unit can run only with the selected mode.

CF28 = 2 Analogue input commands override instrument keyboard commands. If the temperature is within the **CF30** interval, the changing of status is allowed also from instrument keyboard.

If **CF28=1**, **CF28=2** and the unit is running, a request of change the functioning will turn off all the relay outputs. Then the controller will wait few time, signalled by the Chiller or Heat Pump blinking led, before restarting with the compressor delay times of the new functioning.



CF29 Change Over Setpoint.



If the functioning is selected with probe control, it represents the temperature under which **Pb4** probe value automatically turns the unit to Heat Pump mode.

CF30 Change Over differential.

If the functioning is selected with probe control, it represents the temperature differential for **Pb4** probe value to turns the unit to Chiller mode.

CF31 Chiller and Heat Pump keys configuration.

0 = Pushing  key for 5s, it turns on / off the unit in Chiller mode, pushing  key for 5s, it turns on / off in Heat Pump mode.

1 = Pushing  key for 5s, it turns on / off the unit in Heat Pump mode, pushing  key for 5s, it turns on / off the unit in Chiller mode.

CF32 Selects the unit of measurement.

0 = Celsius °C / bar

1 = Fahrenheit / psi

CF33 Selects the power supply frequency.

0 = 50 Hz

1 = 60Hz

CF34 Serial Address for monitoring system.

CF35 Number of remote keyboards push buttons.

0 = 4 push buttons

1 = 6 push buttons

2 = 6 push buttons with NTC sensor

CF36 Default read-out of the display.

0 = Pb1 on the upper side, Pb3 or Pb4 on the lower side.

1 = Pb2 on the upper side, Pb3 or Pb4 on the lower side.

2 = Pb1 on the upper side, the clock on the lower side.

3 = Pb2 on the upper side, the clock on the lower side.

CF37 Firmware release identification.

CF38 Eeprom parameter map identification.

Pr2 Password value from 0 to 999.

36.3 Dynamic Setpoint Parameters

Sd01 Dynamic Setpoint configuration.

0 = Function enabled;

1 = Function disabled.

Sd02 It determines the maximum offset of the setpoint value reachable in Chiller mode.

Sd03 It determines the maximum offset of the setpoint value reachable in Heat Pump mode.

Sd04 External air temperature setpoint in Chiller mode.

Sd05 External air temperature setpoint in H.P. mode.

Sd06 External air temperature differential in Chiller mode.

Sd07 External air temperature differential in Heat Pump mode.

36.4 Energy Saving Parameters

ES01 Energy Saving start time

ES02 Energy Saving stop time

ES03 Monday....ES09 Sunday

0 = Not enabled; 1 = Enabled

ES10 Energy Saving increment in Chiller mode.

ES11 Energy Saving differential in Chiller mode.

ES12 Energy Saving increment in Heat Pump mode.

ES13 Energy Saving differential in Heat Pump mode.

36.5 Compressor Parameters

CO01 Minimum ON time after compressor activation.

CO02 Minimum OFF time after compressor de-activation. During this time the corresponding icon is blinking.

CO03 Delay time between compressor or stage activation to reduce current peak consumption. During this time the corresponding icon is blinking.

When working with a compressor with stage, if there is a full load request, the stage solenoid is activated and only after 5 seconds the compressor. After the delay time CO03 if not needed the stage solenoid is turned off.

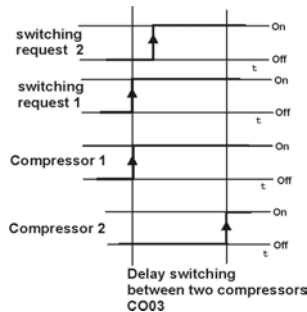

CO04 Off delay time between compressor or stage valve.

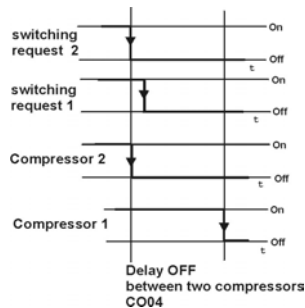

CO05 Delay time at power supply start-up.

All the output relays are delayed for the time set in this parameter to prevent compressor damages from frequent power supply black-outs.

CO06 Compressor switch on delay time after "water pump / air supply fan" relay activation.

Having CO11 = 2 ("water pump / air supply fan" related to compressor on/off status), the "water pump / air supply fan" always starts before the compressors.

Having CO11 = 1 (continuously running of pump/fan) the relay switches on when the controller is turned on in Chiller or Heat Pump mode. No delay time are enabled.

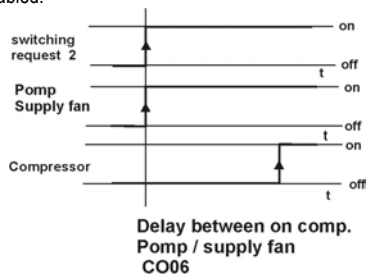

CO07 "Water pump / air supply fan" switch off delay time after compressor deactivating.
 Having CO11 = 2 ("water pump / air supply fan" related to compressor on/off status), the "water pump / air supply fan" always stops after the compressors.
 Having CO11 = 1 (continuously running of pump/fan) the relay switches off when the controller turns to stand-by mode.

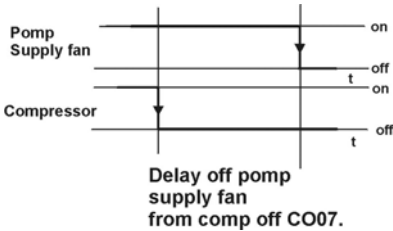

CO08 Compressor control sequences.

0 = Compressor rotating sequence.

Depending on the number of running hours the controller enables the compressor with less counted running hours. The switch off sequence stops the compressor with greater number of running hours.

Rotating sequence is not enabled for units having a compressor with a stage.

1 = Fixed sequence control.

Compressor_1 always starts before Compressor_2 and stops always after Compressor_2 stops.

In case of compressor_1 alarm the compressor_2 immediately stops.

CO09 Reserved.

CO10 Stage polarity valve.

0 = stage active for valve ON (relay closed);

1 = stage active for valve OFF (relay open).

CO11 "Water pump / air supply fan" relay configuration.

0 = Relay not configured..

1 = Continuously running. The relay switches on when the controller is turned to Chiller or Heat Pump mode.

2 = "water pump / air supply fan" is related to compressor on/off status (par CO06 , CO07 activated).

CO12 Compressor_1 off line for maintenance.

0 = ON; 1 = OFF

If set to OFF, the compressor is not more included into the regulation and the relay output will never be turned on. To include the compressor this parameter must be set to 0.

CO13 2nd compressor or stage off line for maintenance.

0 = ON; 1 = OFF

If set to OFF, the compressor is not more included into the regulation and the relay output will never be turned on. To include the compressor this parameter must be set to 0.

CO14 Alarm setpoint for compressor n°1 running hour.

Number of compressor running hour before signalling the warning alarm A13. If 0 the function is not enabled.

CO15 Alarm setpoint for compressor n°2 running hour. Number of compressor running hour before signalling the warning alarm A14. If 0 the function is not enabled.

CO16 Alarm setpoint for pump/fan running hour. Number of pump/fan running hour before signalling the warning alarm A15. If 0 the function is not enabled.

36.6 Ventilation parameters

FA01 It enables the condenser fan output.

0 = Not enabled;

1 = Enabled.

FA02 It selects, with parameter FA03, the type of condenser fan regulation.

0 = (with FA03=0) fan ON with compressor ON.

0 = (with FA03=1) fan ON but independent from compressor and Off in stand-by.

1 = (with FA03=0) fan ON with compressor ON following the ON/OFF regulation of the condensing temperature/pressure trend.

When compressor goes OFF also fan goes OFF.

1 = (with FA03=1) fan ON/OFF following the condensing temperature/pressure trend.

2 = (with FA03=0) fan ON when compressor ON with proportional regulation (triac and 4..20mA outputs) based on condensing pressure/temperature trend. When compressor goes OFF also fan regulation goes OFF.

2 = (with FA03=1) fan ON/OFF with proportional regulation (triac and 4..20mA outputs) based on condensing pressure/temperature trend.

FA03 Condensing fan and compressor status.

0 = Fan related to the compressor status;

1 = Fan independent from compressor.

FA04 Maximum fan speed time after starting request.

If FA02=2 and the condenser fan control is the triac output, when starting the regulation the trigger output will drive the condenser fan at the maximum voltage for the time FA04 then, the regulation will follow the temperature/pressure of the probe.

If FA04 = 0 this function is not enabled.

FA05 Phase shifting of the fan motor.

Used to compensate the different fan motor. It is expressed in micro seconds.

FA06 Not used.

FA07 Maximum fan speed time, in Chiller mode, before switching on the compressor. Used to compensate the condenser pressure rising value to get a better regulation.

If FA07 = 0 this function is not enabled.

FA08 Minimum speed for condenser fan in Chiller mode.

FA09 Maximum speed for condenser fan in Chiller mode.

FA10 Temperature/pressure value that corresponds to the minimum condenser fan speed FA08 in Chiller.

FA11 Temperature/pressure value that corresponds to the maximum condenser fan speed FA09 in Chiller.

FA12 Proportional band for condenser fan control in Chiller mode.

It allows to set the band within the controller increases or decreases the fan speed. (default value is the difference between FA10 and FA11)

FA13 Temperature/pressure differential to stop the condenser fan in Chiller mode.

FA14 Temperature/pressure differential to keep the minimum speed in Chiller mode.

FA15 Time delay before activating the CUT-OFF function after a compressor starting.

If after a compressor starting, the proportional regulation requires to stop the fan (cut-off) and FA15≠0, the condenser fan runs at minimum speed for this time. If FA15=0 the function is not enabled.

FA16 Night function (limited speed) in Chiller

It allows to set a limited speed in Chiller to prevent noises. To enable it the value must be lower than FA11.

FA17 Minimum fan speed in Heat Pump Mode.

FA18 Maximum fan speed in Heat Pump Mode.

FA19 Temperature/pressure value that corresponds to the minimum condenser fan speed in Heat Pump.

FA20 Temperature/pressure value that corresponds to the Maximum condenser fan speed in Heat Pump.

FA21 Proportional band for condenser fan control in Heat Pump mode.

It allows to set the band within the controller increases or decreases the fan speed. (default value is the difference between Fa19 and Fa20).

FA22 Temperature/pressure differential to stop the condenser fan in Heat Pump mode.

FA23 Temperature/pressure differential to keep the regulation with the minimum speed in Heat Pump mode.

FA24 Night function (limited speed) in Heat Pump

It allows to set a limited speed in Heat Pump to prevent noises.

FA25 Hot Start Setpoint.

Temperature value detected by Pb2 under which the supply air fan is stopped.

Only for air/air configuration and heat pump mode.

It starts the fan only if the condenser temperature is hot enough avoiding cold air flows.

FA26 Hot start differential.

36.7 Anti-freeze, Boiler, integration heater parameters

Ar01 Anti-freeze: minimum limit for setpoint Ar03 (−40 °C...Ar03)

Ar02 Anti-freeze: maximum limit for setpoint Ar03 (Ar03...110 °C)

Ar03 Anti-freeze Setpoint (range Ar0 ...Ar02).

Under this value the controller shows an anti-freeze alarm:

Pb1 ambient air low temperature for air/air unit,

Pb2 low outlet temperature for air/air unit.

Ar04 Anti-freeze alarm differential. It determines the alarm reset if temperature is rising.

Ar05 Anti-freeze alarm delay time. It determines the minimum time, with temperature always lower than Ar03, before signalling the anti-freeze alarm.

Ar06 Maximum anti-freeze alarm number before turning to manual reset procedure. After this number of anti-freeze alarms the controller obliges to execute a manual alarm reset.

Ar07 Anti-freeze alarm delay time of the outlet air when starting in Heat Pump mode.

It determines a delay time before signalling the alarm because the Heat Pump mode will heat the water or the air. If after this time the temperature is still lower than Ar03 the unit is immediately turned off.

Ar08 «Anti-freeze heater / integration heater» Setpoint (air/air unit) in Chiller mode.

Temperature value under which the controller switches on the anti-freeze heater (with probe NTC Pb1-Pb2).

Ar09 «Anti-freeze heater / integration heater» Setpoint for air/air unit in Heat Pump mode.

Temperature value under which the controller switches on the anti-freeze heater (with probe NTC Pb1-Pb2).

Ar10 Setpoint anti-freeze heater for water/water unit in Heat Pump mode.

Temperature value under which the controller switches on the anti-freeze heater (with probe NTC Pb3-Pb4).

Ar11 «Anti-freeze heater / integration heater» differential in Chiller mode.

Ar12 «Anti-freeze heater / integration heater» differential in Heat Pump mode.

Ar13 «Anti-freeze heater / integration heater» configuration.

0 = ON with instrument control.

1 = ON with instrument control and active defrost cycle (always on during control)

Ar14 «anti-freeze heater / integration heater» set-up in Chiller.

0 = OFF in Chiller

1 = ON in chiller (on when necessary).

Ar15 anti-freeze heater /integration heater setup in Heat Pump.

0 = OFF in Heat Pump;

1 = ON in Heat Pump (on when necessary)

Ar16 Probe selection for «anti-freeze heater / integration heater» in Chiller mode:

0 = Pb1 probe control;

1 = Pb2 probe control.

Ar17 Probe selection for «anti-freeze heater / integration heater» in Heat Pump mode:

0 = Pb1 probe control;

1 = Pb2 probe control.

Ar18 Anti-freeze heater in Stand-by status. It determines the status of the "anti-freeze heater /integration heater" when the controller functioning is off or stand-by:

0 = Always OFF;

1 = Running on controller demand.

Ar19 Anti-freeze heater safety for faulty probe.

0 = Always off for faulty probe.

1 = Always on for faulty probe.

Boiler Function Parameters

Ar20 The Boiler function allows to control the electrical heater in Heat Pump mode:

0 = Integration control; 1 = Heating control.

Ar21 External air Setpoint for electrical heater control.

Ar22 Boiler temperature differential.

dF04 End defrost temperature/pressure setpoint. When the temperature rising over this value the defrost stops.

dF05 Time delay before starting a forced defrost. The function is enabled if $dF05 < > 0$. It starts a defrost cycle (even if $dF10$ time is not expired), if the temperature/pressure is lower than the set $dF19$ for the time $dF05$ duration. If during $dF05$ the temperature/pressure rises over the set $dF19 + dF20$ (differential) the defrost cycle is postponed and the delay time $dF05$ is reloaded.

dF06 Minimum defrost duration. It determines the minimum time duration of a defrost cycle even if the other end defrost conditions have been already satisfied.

dF07 Maximum defrost duration. It determines the end of the defrost if $dF02 = 1$. In other cases it determines the maximum time.

dF08 Pause time before starting the defrost (the compressor led is blinking). After the $dF10$ delay, before turning on the defrost cycle, the controller stops the compressor for the time set in $dF08$. To allows the pressure balancing, exactly in the middle of the $dF08$ counting ($dF08/2$), the 4-way reversing valve is activated. The delay times of the compressor are not calculated. If $dF08=0$ the compressor does not stops and the 4-way valve is immediately activated.

dF09 Pause time after defrost (the compressor led is blinking). To allows the pressure balancing and the water draining the Heat Pump functioning restarts only after the time set in $dF09$ parameter. In the middle of $dF09$ counting the 4-ways valve is deactivated. The compressor delay times are not calculated.

If $dF09 = 0$ the compressor does not stop and the valve is immediately activated.

dF10 Interval time between defrosts. The counting starts when the condenser temperature/pressure detected (Pb3/Pb4) is lower than $DF03$. In case of supply black-out or changed functioning mode the defrost is postponed and the $dF10$ is reloaded. The counting stops if the compressor stops or if the temperature/pressure becomes higher than $DF03$.

dF11 Start Defrost Setpoint. It is enabled when (Pb4 $CF07=5$) and (Pb3 $CF06=1$ o 2).

The counting begins when the temperature/pressure of Pb3 probe becomes lower than $dF03$. When the $dF10$ delay time is expired the controller check the Pb4, if lower than $dF11$ the defrost starts otherwise the unit will continue in Heat Pump. Just after Pb4 becomes lower than $dF11$ the defrost starts.

dF12 End of combined defrost temperature.

It permits to set the temperature over which the combined defrost stops working.

36.8 Defrost Parameters

dF01 Defrost cycle control.

0 = No; 1 = Yes

dF02 Type of defrost cycle.

0 = Temperature/pressure control. The defrost delay counting time $dF10$ starts just after the temperature/pressure goes below the setpoint $dF03$. The defrost stops for temperature/pressure control.

1 = Maximum time length defrost. The defrost delay counting time $dF10$ begins just after the temperature/pressure goes below the setpoint $dF03$. The defrost stops after the time set in $dF07$.

2 = External contact defrost. The defrost delay counting time $dF10$ begins just after the temperature/pressure goes below the setpoint $dF03$. The defrost starts if the external contact is not active but stops when the contact becomes active.

dF03 Temperature/pressure value under which the defrost delay $dF10$ starts counting.

The analogue input Pb4 configured in CF07 =5 enables the combined end defrost control. The defrost cycle stops when Pb4 reaches this setpoint.

dF13 2nd Compressor ON during the defrost cycle.

0 = OFF; 1 = 2nd Compressor ON

If the unit is configured with 2 compressors CF21=2 and dF13=1, both the compressors are ON in defrost. The delay times are not calculated therefore ON and OFF compressor is instantaneous.

dF14 Condenser Fan ON during defrost and draining cycles (dF09).

0 = Not Enabled;

1 = Enabled only in defrost cycle;

2 = Enabled in defrost and draining cycles.

If dF14=1 and the condensing temperature/pressure increases over dF15 value, the fan control will be driven with the Chiller configuration fan parameter.

If dF14=2 after the defrost, for the time set in dF09 the fan will be forced to maximum speed.

dF15 Temperature/pressure setpoint to force the fan.

dF16 Low alarm detection during defrost.

0 = not enabled; 1 = enabled.

dF17 Low alarm delay time in Heat Pump mode.

With dF08 and dF09 set to 0 (compressor does not stop and 4-ways valve immediately active), the pressure of the circuit is not well balanced for valve changing. In this case the dF17 delay starts counting each time the valve changes its status to avoid stopping the unit for low alarm.

dF18 4-ways inverting valve polarity.

0 = Active in chiller; 1 = Active in Heat Pump.

dF19 Temperature/pressure Setpoint to force the defrost cycle.

dF20 Differential for forced defrost.

The alarm is detected only if the condition persists for the time set in this parameter. The counting starts only after the **AL04** is expired. It prevents from possible alarms due to the presence of air into the water pipe.

Water flow alarm note: the open collector and relay alarm outputs works only for alarm conditions during the functioning. In the other cases the alarm is only displayed with blinking icon. With Boiler function the active alarm stops the pump. The evaporator is automatically protected with the anti-ice control.

CO11=0 Water pump not present.

The alarm is managed only if one of the digital inputs is configured as water flow, the alarm reset is automatic.

CO11=1 "Water pump on" continuously.

The alarm is managed only if one of the digital inputs is configured as water flow, the alarm reset is automatic with Stand-by or remote Off (pump off). The pump is running until reaches AL05 alarm events if working in Chiller or Heat Pump mode. In this case the loads will be deactivated as described in table and the reset turns to manual procedure.

CO11=2 "Water pump on" in parallel with compressor.

The alarm is managed only if one of the digital inputs is configured as water flow, the alarm reset is automatic with Stand-by or remote Off (pump off). It turns to manual reset procedure after reaching AL05 alarm events in Chiller or Heat Pump mode. The loads are deactivated as described in table 34. The water pump follow the cycle with CO06 On delay time and CO07 Off delay time; after AL05 alarm events is stopped.

Water flow alarm manual reset procedure.

After AL05 alarm events it is necessary to enter the function Menu to reset it. The flow icon is lighted and does not disappear if the alarm is still active. The water pump, if managed, can start and the alarm is by-passed for AL04 (to control the unit restart) if during this time the alarm recovers.

AL07 Minimum time with inactive water flow input (after alarm event).

After a water flow alarm event, with stop compressor, the regulation restarts only if after this time the digital input is not more active. It prevents from a possible series of short alarms due to the presence of air into the water pipe.

AL08 Thermal protection alarm delay time for compressors.

After switching on the compressor the thermal protection alarm is not detected for the time set in this parameter.

AL09 Number of maximum thermal protection alarm events.

36.9 Alarm Parameters

AL01 Low pressure alarm delay time.

It determines the time delay before signalling the low pressure alarm from digital input.

AL02 Maximum number of "low pressure alarm" / hour before turning to manual reset procedure

AL03 Low alarm detection with unit in Off or Stand-by.
0 = Alarm not enabled; 1 = Alarm enabled.

AL04 Water flow alarm delay time. After starting the water pump the alarm is suppressed for this time.

AL05 Maximum number of "Water flow alarm" in one hour.

If the number of flow alarm events reaches the value set in this parameter in one hour, the alarm turns to manual reset procedure. The water pump is turned off.

ATTENTION with CF01=2, 3, 4, 5 the minimum value is 1 event.

AL06 Minimum activation time for water flow alarm.

If during one hour the number of thermal alarms reaches the value set in this parameter, the alarm reset turns to manual procedure.

AL10 Thermal protection alarm reset after AL09 events/hour.

After the number of maximum alarms/hour for compressors 1–2, **AL10** parameter automatically change to 1. To reset this alarm is necessary to enter the programming and change it again to 0.

This operation executed only by personnel in charge for the maintenance prevent compressor damaging caused by frequently alarm resets.

AL11 Condensing high temperature/pressure alarm setpoint. When the condenser probe value increases over this value the instrument detects this high alarm.

AL12 Condensing temperature/pressure differential to reset the high alarm.

AL13 Condensing low temperature/pressure alarm delay time for analogue input. After a compressor starting, the low pressure alarm coming from digital input is delayed for the time set in this parameter.

AL14 Condensing low temperature/pressure alarm setpoint. When the condenser probe value decreases under this value the instrument detects this low alarm.

AL15 Condensing temperature/pressure differential to reset the low alarm.

AL16 Maximum number of low pressure alarms in one hour before turning to manual reset procedure.

AL17 Open collector and relay alarm output control when the unit is in Off or in Stand-by status.

0 = Outputs not enabled for alarm events;

1 = Outputs enabled for alarm events.

AL18 Alarm output polarity.

0 = Active for closed contact (open for normal conduit.);

1 = Active for open contact (closed for normal conduit.)

AL19 Alarm printout language through IR device.

0 = Not logged, 1 = Yes 1st Compressor.

LG07 2nd Compressor or valve status.

0 = Not logged, 1 = Yes 2nd Compressor/valve.

LG08 Interval recording time (10 seconds step).

Each time the configuration of LG01-LG07 is changed, the memory automatically deletes the old data and prepares itself for new logging cycle.

36.10 Logging Parameters

The data recording is enabled only for IR device mounted on board and the parameter LG08<>0. The parameters from LG01 to LG07 can enable which are the recordable data .

LG01 Functioning status (Chiller, Heat Pump, Standby)

0 = Not logged, 1 = Yes

LG02 Probe temperature Pb1.

0 = Not logged, 1 = Yes

LG03 Probe temperature Pb2.

0 = Not logged, 1 = Yes

LG04 Probe temperature/pressure Pb2.

0 = Not logged, 1 = Yes

LG05 Probe temperature/pressure Pb4.

0 = Not logged, 1 = Yes.

LG06 1st Compressor status.

37. PARAMETER TABLE

SUB MENU SELECTIONS

LABEL	Meaning
ALL	Shows the whole set of parameters
ST	It contains only the regulation parameters
CF	It contains only the configuration parameters
SD	It contains only the dynamic Set point parameters
ES	It contains only the Energy Saving parameters
CO	It contains only the compressor parameters
FA	It contains only the fan regulation parameters
Ar	It contains only the anti freeze parameters
DF	It contains only the defrost parameters
AL	It contains only the alarm parameters
LG	It contains only the logging parameters

PARAMETER DESCRIPTION

Regulation Parameters					
Parameter	Description	Min	Max	Meas.	Resolution
ST01	Summer Set point	ST05	ST06	°C/°F	Decimal integer
ST02	Summer differential	0.0 0	25.0 45	°C °F	Decimal integer
ST03	Winter Set point	ST07	ST08	°C/°F	Decimal integer
ST04	Winter differential	0.0 0	25.0 45	°C °F	Decimal integer
ST05	Minimum set point limit for ST01 (summer)	-40.0 -40.0	ST01	°C °F	Decimal integer
ST06	Maximum set point limit for ST01 (summer)	ST01	110 230	°C °F	Decimal integer
ST07	Minimum set point limit for ST03 (winter)	-40.0 -40.0	ST03	°C °F	Decimal integer
ST08	Maximum set point limit for ST03 (winter)	ST03	110 230	°C °F	Decimal integer
ST09	Regulation band	0.0 0	25.0 45	°C °F	Decimal integer
Pr2	Password	0	999		

Configuration Parameters					
Parameter	Description	Min	Max	Meas.	Resolution
CF01	Unit model: 0= Chiller air / air 1= Chiller air / air with heat pump 2= Chiller air / water 3= Chiller air / water with heat pump 4= Chiller water / water 5= Chiller water / water with heat pump	0	5		
CF02	Motocondensing unit 0= No 1= Yes	0	1		
CF03	Regulation probe 0= Pb1 regulation 1= Pb2 regulation	0	1		
CF04	Pb1 configuration 0= Probe not enabled 1= NTC temperature of evaporator inlet 2= Digital input for temperature regulation demand 3= Digital input cooling demand	0	3		
CF05	Pb2 configuration 0= Probe not enabled 1= NTC temperature of evaporator outlet 2= Digital Input for antifreeze alarm 3= Digital input for heating demand	0	3		
CF06	Pb3 configuration 0= Probe not enabled 1= NTC temperature condensing control 2= 4..20mA for condensing pressure 3= 4..20ma for Dynamic Set point 4= NTC temperature for anti freeze alarm (water/water)	0	4		
CF07	Pb4 configuration 0= Probe not enabled 1= NTC condensing control 2= Multifunction digital input 3= External air temperature 4= NTC temperature for anti freeze alarm (water/water) 5= NTC temperature for combined defrost 6= NTC temperature for logging	0	6		
CF08	ID1 configuration 0= 1 st compressor thermal protection 1= Condenser fan thermal protection 2= Supply air fan thermal protection 3= Remote On/off 4= Cooling/Heating 5= 2 nd compressor thermal protection 6= 2 nd compressor or step request (Motocondensing unit) 7= End defrost 8= Energy Saving 9= Anti Freeze alarm	0	9		

CF09	ID2 0= 1 st compressor thermal protection 1= Condenser fan thermal protection 2= Supply air fan thermal protection 3= Remote On/off 4= Cooling/Heating 5= 2 nd compressor thermal protection 6= 2 nd compressor or step request (Motocondensing unit) 7= End defrost 8= Energy Saving 9= Anti Freeze alarm	0	9		
CF10	ID5 configuration 0= 1 st compressor thermal protection 1= Condenser fan thermal protection 2= Supply air fan thermal protection 3= Remote On/off 4= Cooling/Heating 5= 2 nd compressor thermal protection 6= 2 nd compressor or step request (Motocondensing unit) 7= End defrost 8= Energy Saving 9= Anti Freeze alarm	0	9		
CF11	Pb4 configuration in digital input mode 0= 1 st compressor thermal protection 1= Condenser fan thermal protection 2= Supply air fan thermal protection 3= Remote On/off 4= Cooling/Heating 5= 2 nd compressor thermal protection 6= 2 nd compressor or step request (Motocondensing unit) 7= End defrost 8= Energy Saving 9= Anti Freeze alarm	0	9		
CF12	ID1 input polarity 0= active for closed contact 1= active for open contact	0	1		
CF13	ID2 input polarity 0= active for closed contact 1= active for open contact	0	1		
CF14	ID3 input polarity 0= active for closed contact 1= active for open contact	0	1		
CF15	ID4 input polarity 0= active for closed contact 1= active for open contact	0	1		
CF16	ID5 input polarity 0= active for closed contact 1= active for open contact	0	1		
CF17	Pb1 input polarity 0= active for closed contact 1= active for open contact	0	1		
CF18	Pb2 input polarity 0= active for closed contact 1= active for open contact	0	1		

CF19	Pb4 input polarity 0= active for closed contact 1= active for open contact	0	1		
CF20	RL4 configuration of the relay 4 0= Reversing valve 1= ON / OFF condenser fan	0	1		
CF21	RL5 configuration of the relay 5 0= General alarm 1= one compressor with 1 stage valve 2= Compressor 2 3= ON / OFF condenser fan	0	3		
CF22	4mA corresponding to the pressure value of the transducer	0.0 0	31.0 449	Bar Psi	Decimal integer
CF23	20mA corresponding to the pressure value of the transducer	0.0 0	31.0 449	Bar Psi	Decimal integer
CF24	Pb1 Offset	-12.0 -21.6	12.0 21.6	°C °F	Decimal integer
CF25	Pb2 Offset	-12.0 -21.6	12.0 21.6	°C °F	Decimal integer
CF26	Pb3 Offset	-12.0 -21.6 -12 -174	12.0 21.6 12 174	°C °F Bar Psi	Decimal Integer Decimal integer
CF27	Pb4 Offset	-12.0 -21.6	12.0 21.6	°C °F	Decimal integer
CF28	Chiller or Heat Pump starting command priority 0= Instrument keyboard 1= Digital Input 2= Analogue input (probe)	0	2		
CF29	Automatic Changeover Setpoint	-40 -40	110 230	°C °F	Decimal integer
CF30	Differential for functioning mode	0.0 0	25.0 45	°C °F	Decimal integer
CF31	Chiller or Heat pump key configuration 0= ❄️ chiller / 🔥 heat pump 1= 🔥 chiller / ❄️ heat pump	0	1		
CF32	Celsius or Fahrenheit selection 0= °C / °BAR 1= °F / °psi	0	1		
CF33	Power supply frequency 0= 50 Hz 1= 60 Hz	0	1		
CF34	Serial Address for monitoring	1	247		
CF35	Remote terminal keyboard 0= 4 keys 1= 6 keys 2= 6 keys with NTC probe mounted on board	0	2		
CF36	Default display read-out 0= Pb1 / probe 1= Pb2 / probe 2= Pb1 / rtC 3= Pb2 / rtC	0	3		
CF37	Firmware Release				

CF38	Eeprom – Parameter mapping				
Pr2	Password value	0	999		
Dynamic Setpoint					
Parameter	Description	Min	Max	Meas	Resolution
Sd01	Dynamic Setpoint 0= Not enabled 1= Enabled	0	1		
Sd02	Maximum summer dynamic Offset	- 30 -54	30 54	°C °F	Decimal integer
Sd03	Maximum winter dynamic Offset	- 30 -54	30 54	°C °F	Decimal integer
Sd04	External air d. setpoint during summer	-40 -40	110 230	°C °F	Decimal integer
Sd05	External air d. setpoint during winter	-40 -40	110 230	°C °F	Decimal integer
Sd06	External air differential during summer	- 30 -54	30 54	°C °F	Decimal integer
Sd07	External air differential during winter	- 30 -54	30 54	°C °F	Decimal integer
Pr2	Password value	0	999		
Energy Saving					
Parameter	Description	Min	Max	Meas	Resolution
ES01	Energy saving starting hour (0+24)	0	23.50	Min	10 Min
ES02	Energy saving ending hour (0+24)	0	23.50	Min	10 Min
ES03...ES09	Monday...Sunday 0 = Not enabled 1= Enabled	0	1		
ES10	Energy saving setpoint offset in chiller	-30.0 -54	30.0 54	°C °F	Decimal integer
ES11	Energy saving differential in chiller	0.1 0	25.0 45	°C °F	Decimal integer
ES12	Energy saving setpoint offset in heat pump	-30.0 -54	30.0 54	°C °F	Decimal integer
ES13	Energy saving differential in heat pump	0.1 0	25.0 45	°C °F	Decimal integer
Pr2	Password value	0	999		
Compressor parameters					
Parameter	Description	Min	Max	Meas.	Resolution
CO01	Minimum ON time	0	250	Sec	10Sec
CO02	Minimum OFF time	0	250	Sec	10Sec
CO03	ON delay time between two compressors or Comp. and valve	1	250	Sec	
CO04	OFF delay time between two compressors or Comp. and valve	0	250	Sec	
CO05	Output time delay after power supply start-up	0	250	Min	
CO06	Compressor On delay time after Pump/"Supply fan" activation	1	250	Sec	
CO07	Compressor OFF delay time after Pump/"Supply fan" de-activation	0	250	Sec	
CO08	Compressor rotating control 0= Enabled 1= Fixed sequence	0	1		
CO09	Nod Used				

CO10	Stage vale polarity 0= Capacity stage ON 1= Capacity stage OFF	0	1		
CO11	Pump/"Supply fan" operating mode 0= Not used 1= Continuously 2= Only for compressor demand	0	2		
CO12	Compressor 1 0 = Enabled 1 = OFF	0	1		
CO13	Compressor 2 / Stage valve. 0 = Enabled 1= OFF	0	1		
CO14	Hour counter setpoint for 1 st compressor	0	999	Hr	10 Hr
CO15	Hour counter setpoint for 2 nd compressor	0	999	Hr	10 Hr
CO16	Hour counter setpoint for pump/"Supply fan"	0	999	Hr	10 Hr
Pr2	Password	0	999		
Fan control parameter					
Parameter	Description	Min	Max	Meas.	Resolution
FA01	Fan output 0= Enabled 1= Not enabled	0	1		
FA02	Fan regulation 0= On when compressor On 1= ON / OFF 2= Proportional speed control	0	2		
FA03	Fan related to compressor 0= With compressor 1= Independent from compressor	0	1		
FA04	Maximum speed time when the fan starting	0	250	Sec	
FA05	Phase difference fan	0	20	Micro Sec	250µs
FA06	Not used				
FA07	Cooling pre-ventilation before ON compressor	0	250	Sec	
FA08	Minimum fan speed in summer	30	100	%	
FA09	Maximum fan speed in summer	30	100	%	
FA10	Temperature / pressure setpoint for minimum speed in summer	-40.0	110	°C	Decimal
		- 40	230	°F	integer
		0.0	30	Bar	Decimal
		0	435	Psi	integer
FA11	Temperature / pressure setpoint for maximum speed in summer	-40.0	110	°C	Decimal
		- 40	230	°F	integer
		0.0	30	Bar	Decimal
		0	435	Psi	integer
FA12	Proportional band in summer	0.0	25.0	°C	Decimal
		0	45	°F	integer
		0.0	30.0	Bar	Decimal
		0	435	Psi	Integer

FA13	CUT-OFF differential in summer	0.0 0 0 0	25.0 45 30.0 435	°C °F Bar Psi	Decimal integer Decimal integer
FA14	Override CUT-OFF in summer	0.0 0 0.0 0	25.0 45 30.0 435	°C °F Bar Psi	Decimal integer Decimal integer
FA15	Delay time for CUT-OFF	0	250	Sec	
FA16	Fan speed in summer night function	30	100	%	
FA17	Minimum fan speed in winter	30	100	%	
FA18	Maximum fan speed in winter	30	100	%	
FA19	Temperature / pressure setpoint for minimum speed in winter	-40.0 -40 0.0 0	110 230 30 435	°C °F Bar Psi	Decimal integer Decimal integer
FA20	Temperature / pressure setpoint for maximum speed in winter	-40.0 -40 0.0 0	110 230 30 435	°C °F Bar Psi	Decimal integer Decimal integer
FA21	Proportional band in winter	0.0 0 0.0 0	25.0 45 30.0 435	°C °F Bar Psi	Decimal integer Decimal integer
FA22	CUT-OFF differential in winter	0.0 0 0.0 0	25.0 45 30.0 435	°C °F Bar Psi	Decimal integer Decimal integer
FA23	Override CUT-OFF in winter	0.0 0 0.0 0	25.0 45 30.0 435	°C °F Bar Psi	Decimal integer Decimal integer
FA24	Fan speed in winter night function	30	100	%	
Hot Start Function					
Parameter	Description	Min	Max	Meas.	Resolution
FA25	Hot Start Setpoint	-40 -40	110 230	°C °F	Decimal integer
FA26	Hot Start differential	0.0 0	25.0 45	°C °F	Decimal integer
Pr2	Password	0	999		
Anti-freeze / Heater parameters					
Parameter	Description	Min	Max	Meas.	Resolution
Ar01	Minimum value of Anti-Freeze Setpoint	-40.0 -40	Ar03 110	°C °F	Decimal integer
Ar02	Maximum value of Anti-Freeze Setpoint	Ar03	110 230	°C °F	Decimal integer
Ar03	Anti-freeze Setpoint	Ar01	Ar02	°C/°F	Dec/int
Ar04	Anti-Freeze Differential	0 0	25.0 45	°C °F	Decimal integer
Ar05	Anti-Freeze alarm delay	0	250	Sec	
Ar06	Maximum number of Anti-Freeze alarm events in 1 hour	0	16		

Ar07	Anti-Freeze alarm delay after starting in Heat Pump	0	250	Sec	
Ar08	Anti-Freeze Setpoint of the electrical heater in Chiller mode	-40 -40	110 230	°C °F	Decimal integer
Ar09	Anti-Freeze Setpoint of the electrical heater in Heat Pump mode	-40 -40	110 230	°C °F	Decimal integer
Ar10	Anti-Freeze Setpoint of external electrical heater (water/water units)	-40 -40	110 230	°C °F	Decimal integer
Ar11	Anti-Freeze Differential in Chiller	0 0	25.0 45	°C °F	Decimal integer
Ar12	Anti-Freeze Differential in Heat Pump	0 0	25.0 45	°C °F	Decimal integer
Ar13	Anti-freeze electrical heater regulation 0= enabled during regulation control 1= enabled active during regulation an defrost	0	1		
Ar14	Anti-freeze electrical heater regulation in Chiller mode 0= OFF in chiller 1= ON in chiller	0	1		
Ar15	Anti-freeze electrical heater regulation in H.P. mode 0= OFF in Heat Pump 1= ON in Heat Pump	0	1		
Ar16	Anti-freeze control probe in Chiller mode 0= Pb1 1= Pb2	0	1		
Ar17	Anti-freeze control probe in Heat Pump mode 0= Pb1 1= Pb2	0	1		
Ar18	"Water pump"/ "Anti-freeze electrical heater" control with unit in OFF or Stand-by 0= Regulation not enabled 1= Regulation enabled	0	1		
Ar19	"Water pump"/ "Anti-freeze electrical heater" control for faulty probe 0= output OFF for faulty probe 1= output ON for faulty probe	0	1		
Function Boiler					
Parameter	Description	Min	Max	Meas.	Resolution
Ar20	Boiler function 0= Integration control 1= Heating control	0	1		
Ar21	External air Setpoint for Boiler heater activation	-40.0 -40	110 230	°C °F	Decimal integer
Ar22	Boiler function differential	0 0	25.0 45	°C °F	Decimal integer
Pr2	Password	0	999		
Defrost Parameters					
Parameter	Description	Min	Max	Meas.	Resolution
DF01	Defrost control 0= No 1= Yes	0	1		
DF02	Defrost type 0= Temperature / pressure 1= Time 2= External contact	0	2		

DF03	Temperature / pressure Setpoint for starting the defrost cycle	-40.0 - 40 0.0 0	110 230 30 435	°C °F Bar Psi	Decimal integer Decimal integer
DF04	Temperature / pressure Setpoint for stopping the defrost cycle	-40.0 - 40 0.0 0	110 230 30 435	°C °F Bar Psi	Decimal integer Decimal integer
DF05	Minimum delay time before starting a forced defrost cycle	0	250	Sec	
DF06	Minimum defrost duration	0	250	Sec	
DF07	Maximum defrost duration	0	250	Min	
DF08	Compressor Off time before starting a defrost cycle	0	250	Sec	
DF09	Compressor Off time after a defrost cycle	0	250	Sec	
DF10	Interval time between defrost cycles	0	99	MIN	
DF11	Temperature setpoint to start a combined defrost cycle after the DF10 counting time	-40 -40	110 230	°C °F	Decimal integer
DF12	Temperature Setpoint to stop a combined defrost	-40 -40	110 230	°C °F	Decimal integer
DF13	Forced activation of the 2 nd compressor in defrost 0= Not enabled 1= Enabled	0	1		
DF14	Forced fan activation during defrost and draining times 0= Not enabled 1= Enabled only for defrost 2= Enabled for defrost and draining time (dF09)	0	2		
DF15	Temperature/Pressure Setpoint to start a forced condensing fan control in defrost cycle	-40.0 - 40 0.0 0	110 230 30 435	°C °F Bar Psi	Decimal integer Decimal integer
DF16	Low alarm control during defrost 0= Not enabled 1= Enabled	0	1		
DF17	Low alarm delay time after changing the status of the 4-ways valve	0	250	Sec	
DF18	4-ways reversing valve 0= ON in cooling 1= ON in heating	0	1		
DF19	Temperature/pressure Setpoint to start a forced defrost cycle	-40.0 - 40 0.0 0	110 230 30 435	°C °F bar psi	Decimal integer Decimal integer
DF20	Forced defrost cycle differential	0 0	25.0 45	°C °F	Decimal integer
Pr2	Password	0	999		
Alarm Parameter					
Parameter	Description	Min	Max	Meas.	Resolution
AL01	Low pressure alarm delay time	0	250	Sec	
AL02	Maximum low pressure alarm events in 1 hour	0	16		
AL03	Low pressure alarm with off compressor 0= Not enabled when compressor Off 1= Enabled when compressor Off	0	1		
AL04	"Water flow/Supply fan thermal protection" alarm delay after "water pump / supply air fan" starting.	0	250	Sec	

AL05	Maximum number of "Water flow"/"Supply fan thermal protection" alarm events in 1 hour	0	16		
AL06	"Water flow/Supply fan thermal protection" input activation duration	0	250	Sec	
AL07	"Water flow/Supply fan thermal protection" input de-activation duration	0	250	Sec	
AL08	Thermal protection alarm delay after starting the compressor	0	250	Sec	
AL09	Maximum number of compressor thermal protection alarm events in 1 hour	0	16		
AL10	Compressor thermal protection alarm reset after AL09 parameter	0	1		
AL11	Condensing temperature/pressure high alarm setpoint	-40.0 - 40 0.0 0	110 230 30 435	°C °F Bar Psi	Decimal integer Decimal integer
AL12	Temperature/pressure high alarm differential	0 0 0 0	25.0 45 30.0 435	°C °F Bar Psi	Decimal integer Decimal integer
AL13	Low pressure alarm delay for input probe	0	250	Sec	
AL14	Low pressure alarm Setpoint for input probe	-40.0 - 40 0.0 0	110 230 30 435	°C °F Bar Psi	Decimal integer Decimal integer
AL15	Low pressure differential for input probe	0 0 0 0	25.0 45 30.0 435	°C °F Bar Psi	Decimal integer Decimal integer
AL16	Maximum number of the low alarm events in 1 hour for input probe	0	16		
AL17	Open collector and relay alarm output control with unit in Off or stand-by 0= Alarm outputs enabled 1= Alarm outputs not enabled	0	1		
AL18	Alarm relay output polarity 0= Active alarm for closed contact 1= Active alarm for open contact	0	1		
AL19	Language selection for alarm print-out via IR 0= Italiano 1= English	0	2		
Pr2	Password	0	999		

Data Logging

Parameter	Description	Min	Max	Meas.	Resolution
LG01	Instrument status (chiller, heat pump, stand-by) 0 = No 1 = Yes	0	1		
LG02	Pb1 logging 0 = No 1 = Yes	0	1		

LG03	Pb2 logging 0 = No 1 = Yes	0	1		
LG04	Pb3 logging 0 = No 1 = Yes	0	1		0.5 °C 0.9°F 0.5 bar 7.2 Psi
LG05	Pb4 logging 0 = No 1 = Yes	0	1		0.5 °C
LG06	1 st compressor logging 0 = No 1 = Yes	0	1		
LG07	2 nd compressor / stage valve logging 0 = No 1 = Yes	0	1		
LG08	Logging interval time 0 = Logging not enabled	0	250	Sec	10
Pr2	Password	0	999		

SUB-MENU SELECTION

Par. CF01	Value					
	0	1	2	3	4	5
Label ST	x	x	x	x	x	x
Label CF	x	x	x	x	x	x
Label Sd	x	x	x	x	x	x
Label ES	x	x	x	x	x	x
Label CO	x	x	x	x	x	x
Label FA	x	x	x	x		
Label Ar	x	x	x	x	x	x
Label dF		x		x		
Label AL	x	x	x	x	x	x
Label LG	x	x	x	x	x	x

With “ALL” selection only the enabled menu are visible

SUB-MENU SELECTION

Par. CF01 with CF02=1	Value					
	0	1	2	3	4	5
Label ST						
Label CF	x	x	x	x	x	x
Label Sd						
Label ES						
Label CO	x	x	x	x	x	x
Label FA	x	x	x	x		
Label Ar	x	x	x	x	x	x
Label dF		x		x		
Label AL	x	x	x	x	x	x
Label LG	x	x	x	x	x	x

With “ALL” selection only the enabled menu are visible

38. TECHNICAL DATA

Housing: Self extinguishing ABS.

Case: Front panel 32x74 mm, depth 60mm ("C" format);
Front panel 38x185 mm; depth 75mm ("L" format)

Mounting: "C" format panel mounting in a 29x71 mm panel cut-out
"L" format panel mounting in a 150x31 mm panel cut-out with two screws. \varnothing 3 x 2mm. Distance between the holes 165mm

Protection: IP65.

Frontal protection: IP65 with frontal gasket mod RG-L or C model.

Connections: Removable terminal block 12 and 14 ways;

Power supply: 12Vac/dc \pm 10%, 24Vac/dc \pm 10%, 50-60Hz.

Power absorption: 5VA max.

Display: 3 digits red led and 4 digit orange led.

Inputs: 4 NTC probes, or 3 NTC probes and one 4..20mA.

Digital inputs: 5 free voltage

Relay outputs: 5 relay SPDT 8(3)A, 250Vac

Open collector: alarm output: 12V, 40mA.

Analogue output: 4..20mA for fan control, trigger for fan control

Serial output: TTL standard **Communication protocol:** Modbus – RTU

Data storing: on the non-volatile memory (EEPROM).

Kind of action: 1B.

Pollution grade: normal

Software class: A.

Operating temperature: 0+60 °C.

Storage temperature: -25+60 °C.

Relative humidity: 20-85% (no condensing)

Measuring range: NTC probe: -40+110°C.

Resolution: 0,1 °C or 1°C.

Accuracy (ambient temp. 25°C): \pm 0,5 °C \pm 1 digit

Dixell s.r.l. Z.I. Via dell'Industria, 27
32010 Pieve d'Alpago (BL) ITALY
tel. +39 - 0437 - 98 33 - fax +39 - 0437 - 98 93 13
E-mail: dixell@dixell.com - <http://www.dixell.com>