

Thermostat with off cycle defrost

XR80C

CONTENTS

- 1. GENERAL WARNING _____ 1
- 2. GENERAL DESCRIPTION _____ 1
- 3. CONTROLLING LOADS _____ 1
- 4. FRONT PANEL COMMANDS _____ 1
- 5. MAXIMUM AND MINIMUM TEMPERATURE FUNCTIONS _____ 1
- 6. MAIN FUNCTIONS _____ 2
- 7. LIST OF PARAMETERS _____ 2
- 8. INSTALLATION AND MOUNTING _____ 2
- 9. ELECTRICAL CONNECTIONS _____ 3
- 10. HOW TO USE THE HOT KEY _____ 3
- 11. ALARM SIGNALS _____ 3
- 12. TECHNICAL DATA _____ 3
- 13. CONNECTIONS _____ 3
- 14. DEFAULT SETTING VALUES _____ 4

1. GENERAL WARNING

1.1 PLEASE READ BEFORE USING THIS MANUAL

- This manual is part of the product and should be kept near the instrument for easy and quick reference.
- The instrument shall not be used for purposes different from those described hereunder. It cannot be used as a safety device.

1.2 SAFETY PRECAUTIONS

- Check the supply voltage is correct before connecting the instrument.
- Do not expose to water or moisture: use the controller only within the operating limits avoiding sudden temperature changes with high atmospheric humidity to prevent formation of condensation
- Warning: disconnect all electrical connections before any kind of maintenance.
- The instrument must not be opened.
- Fit the probe where it is not accessible by the end user.
- In case of failure or faulty operation send the instrument back to the distributor or to "Dixell s.r.l." (see address) with a detailed description of the fault.
- Consider the maximum current which can be applied to each relay (see Technical Data).
- Ensure that the wires for probes, loads and the power supply are separated and far enough from each other, without crossing or intertwining.
- In case of applications in industrial environments, the use of mains filters (our mod. FT1) in parallel with inductive loads could be useful.

2. GENERAL DESCRIPTION

Models XR80C, 32x 74 format, is a microprocessor based controller suitable for application in the milk preservation / refrigeration sector. It is equipped with one thermostat probe and two relay outputs to control the compressor and agitator. The XR180 allows a very accurate control of all the main functions required during the "milk-tank preservation" cycles, including the timed cycles of agitator functions. The operator can also manually start a timed agitation cycle by pushing the ▲ key on the instrument's front panel. Each instrument is fully configurable through special parameters that can be easily programmed through the keypad.

3. CONTROLLING LOADS

3.1 THE COMPRESSOR

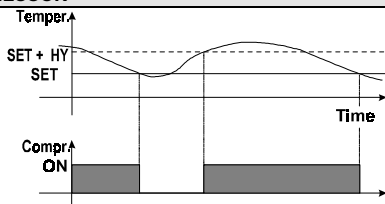

The regulation is performed according to the temperature measured by the thermostat probe with a positive differential from the set point: if the temperature increases and reaches set point plus differential the compressor is started and then turned off when the temperature reaches the set point value again. In case of fault in the thermostat probe the start and stop of the compressor are timed through parameters "CO_n" and "CO_F".

3.2 AGITATION CYCLE

The functions of the agitator can be selected by means of the AgC parameter. AgC = EL (parallel) the agitator always operates when the compressor is running and continues to do so for a length of time - which can be set in parameter "Agt" (Duration of agitation cycle)- even after the compressor stops. If the compressor does not run longer than the time set in parameter "IAG" (Interval between agitation cycles), the agitator will start to function anyway for the length of time set in parameter Agt. AgC= in independent agitator. The agitator is switched ON and OFF according to the IAG parameter independently from the state of the compressor. It operates for the time set in the Agt parameter.

3.3 MANUAL AGITATION CYCLE

It can be started by means of the ▲ key, by holding it pressed for 3 seconds. Agitator remains ON for the time set in Agt parameter. The compressor keeps with the normal regulation.

4. FRONT PANEL COMMANDS

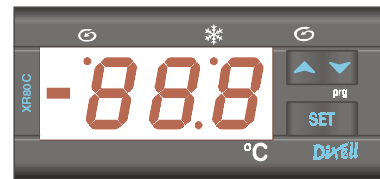

- SET:** To display target set point; in programming mode it selects a parameter or confirm an operation.
- ▲ (UP): To see the max. stored temperature; in programming mode it browses the parameter codes or increases the displayed value.
TO START A MANUAL AGITATION CYCLE: in normal operation, by holding it pressed for 3s the agitation cycle is started.
 - ▼ (DOWN) To see the min stored temperature; in programming mode it browses the parameter codes or decreases the displayed value.

KEY COMBINATIONS:

- ▲ + ▼ To lock & unlock the keyboard.
- SET + ▼ To enter in programming mode.
- SET + ▲ To return to the room temperature display.

4.1 MEANING OF LEDS

Each LED function is described in the following table.

LED	MODE	FUNCTION
❄	ON	Compressor enabled
❄	Flashing	-Programming Phase (flashing with ⌚) - Anti-short cycle delay enabled
⌚	ON	Agitator enabled
⌚	Flashing	- Programming Phase (flashing with ❄)

5. MAXIMUM AND MINIMUM TEMPERATURE FUNCTIONS

5.1 HOW TO SEE THE MIN TEMPERATURE

1. Press and release the ▼ key.
2. The "Lo" message will be displayed followed by the minimum temperature recorded.
3. By pressing the ▼ key again or by waiting 5s the normal display will be restored.

5.2 HOW TO SEE THE MAX TEMPERATURE

1. Press and release the ▲ key.
2. The "Hi" message will be displayed followed by the maximum temperature recorded.
3. By pressing the ▲ key again or by waiting 5s the normal display will be restored.

5.3 HOW TO RESET THE MAX AND MIN TEMPERATURE RECORDED

1. Hold press the SET key for more than 3s, while the max. or min temperature is displayed. (rSt message will be displayed)
 2. To confirm the operation the "rSt" message starts blinking and the normal temperature will be displayed.
- XR80C signals and records temperature alarms, together with their duration and max value reached. See drawing:

6. MAIN FUNCTIONS

6.1 HOW TO SEE THE SETPOINT

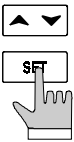

Push and immediately release the **SET** key: the display will show the Set point value;

6.2 HOW TO CHANGE THE SETPOINT

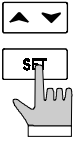

1. Push the **SET** key for more than 2 seconds to change the Set point value;
2. The value of the set point will be displayed and the LED starts blinking;
3. To change the Set value push the arrows.
4. To memorise the new set point value push the **SET** key again or wait 15s.

6.3 HOW TO START A MANUAL AGITATION CYCLE

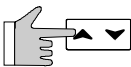

Push the **UP** key for more than 2 seconds and a manual agitation cycle will start.

6.4 HOW TO CHANGE A PARAMETER VALUE

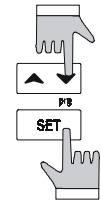

- To change the parameter's value operate as follows:
1. Enter the Programming mode by pressing the Set and UP key for 3s (and start blinking).
 2. Select the required parameter.
 3. Press the "**SET**" key to display its value (LED starts blinking).
 4. Use "**UP**" or "**DOWN**" to change its value.
 5. Press "**SET**" to store the new value and move to the following parameter.

To exit: Press **SET** + **UP** or wait 15s without pressing a key.

NOTE: the set value is stored even when the procedure is exited by waiting the time-out to expire.

6.5 THE HIDDEN MENU

The hidden menu Includes all the parameters of the instrument.

6.5.1 HOW TO ENTER THE HIDDEN MENU

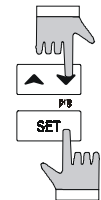

1. Enter the Programming mode by pressing the Set + key for 3s (and start blinking).
2. When a parameter is displayed keep pressed the Set+ for more than 7s. The Pr2 label will be displayed immediately followed from the HY parameter. **NOW YOU ARE IN THE HIDDEN MENU.**
3. Select the required parameter.
4. Press the "**SET**" key to display its value (Now only the LED is blinking).

5. Use to change its value.

6. Press "**SET**" to store the new value and move to the following parameter.

To exit: Press **SET** + or wait 15s without pressing a key.

NOTE: the set value is stored even when the procedure is exited by waiting the time-out to expire.

6.5.2 HOW TO MOVE A PARAMETER FROM THE HIDDEN MENU TO THE FIRST LEVEL AND VICEVERSA.

Each parameter present in the HIDDEN MENU can be removed or put into "THE FIRST LEVEL" (user level) by pressing "**SET** + .

In HIDDEN MENU when a parameter is present in First Level the decimal point is on.

6.6 HOW TO LOCK THE KEYBOARD

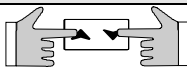

1. Keep pressed for more than 3 s the UP and DOWN keys.
2. The "POF" message will be displayed and the keyboard will be locked. At this point it will be possible only to see the set point or the MAX o Min temperature stored
3. If a key is pressed more than 3s the "POF" message will be displayed.

6.7 TO UNLOCK THE KEYBOARD

Keep pressed together for more than 3s the UP and DOWN keys.

7. LIST OF PARAMETERS

NOTE: the parameters preceded by dots usually are only in the Hidden Menu.

REGULATION

Hy Differential: (0,1 ÷ 25,5°C / 1÷255 °F) Intervention differential for set point. Compressor Cut IN is Set Point Plus Differential (Hy). Compressor Cut OUT is when the temperature reaches the set point.

- **LS Minimum set point:** (- 50°C÷ SET / -58°F÷SET): Sets the minimum acceptable value for the set point.
- **US Maximum set point:** (SET÷ 150°C / SET÷302°F). Set the maximum acceptable value for set point.

Ot Thermostat probe calibration: (-12.0÷12.0°C; -120÷120°F) allows the adjustment of possible offset of the thermostat probe.

- **OdS Outputs activation delay at start up:** (0÷255min) This function is enabled at the initial start up of the instrument and inhibits any output activation for the period of time set in the parameter.

AC Anti-short cycle delay: (0÷50 min) minimum interval between the compressor stop and the following restart.

- **COn Compressor ON time with faulty probe:** (0÷255 min) time during which the compressor is active in case of faulty thermostat probe. With COn=0 compressor is always OFF.
- **COF Compressor OFF time with faulty probe:** (0÷255 min) time during which the compressor is OFF in case of faulty thermostat probe. With COF=0 compressor is always active.

DISPLAY

- **CF Temperature measurement unit:** °C = Celsius; °F= Fahrenheit. **WARNING:** When the measurement unit is changed the SET point and the values of the parameters Hy, LS, US, Ot, ALU and ALL have to be checked and modified if necessary).

rES Resolution (for °C): (in = 1°C; dE = 0.1 °C) allows the decimal point displaying.

AGITATION CYCLE

- **AgC Agitator configuration** EL = switched ON and OFF with the compressor; in = switched ON according to parameter IAG.
- **tiC Resolution for the Agt parameter** nP = the Agt parameter is in minutes Pb = the Agt parameter is in seconds

iAG Interval between agitation cycles: (1÷120 min) Determines the time interval between the beginning of two agitation cycles. **NOTE:** When a continuous agitation cycle is started, the time counting is reset and starts from zero.

Agt Length for agitation cycle: (0÷255 min/sec) It sets the agitation cycle duration.

APO First agitation cycle after start-up: (y = Immediately; n= after the IAG time)

ALARMS

- **ALC Temperature alarms configuration:** (Ab; rE)
Ab= absolute temperature: alarm temperature is given by the ALL or ALU values. rE = temperature alarms are referred to the set point. Temperature alarm is enabled when the temperature exceeds the "SET+ALU" or "SET-ALL" values.

ALU MAXIMUM temperature alarm: (ALL÷150°C; ALL ÷ 302°F) when this temperature is reached the alarm is enabled, after the "ALd" delay time.

ALL Minimum temperature alarm: (-50.0°C ÷ ALU; -58°F ÷ ALU) when this temperature is reached the alarm is enabled, after the "ALd" delay time.

- **ALd Temperature alarm delay:** (0÷255 min) time interval between the detection of an alarm condition and alarm signalling.

- **dAO Exclusion of temperature alarm at startup:** (from 0.0 min to 23.5h) time interval between the detection of the temperature alarm condition after instrument power on and alarm signalling.

OTHER

- **PbC Probe selection:** (Ptc=PTC probe; ntc=NTC probe). It allows the selection of the type of probe.
- **rEL Software release for internal use.**
- **Ptb Parameter table code:** readable only.

8. INSTALLATION AND MOUNTING

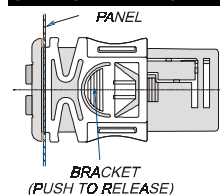

Instrument **XR80C** shall be mounted on panel, in a 29x71 mm hole, and fixed using the special bracket supplied.

To obtain an IP65 protection grade use the front panel rubber gasket (mod. RG-C) as shown in figure.

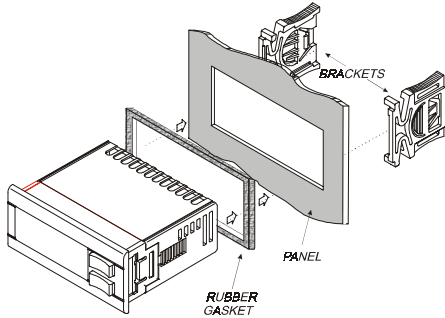

The temperature range allowed for correct operation is 0÷60 °C. Avoid places subject to strong vibrations, corrosive gases, excessive dirt or humidity. The same recommendations apply to probes. Let air circulate by the cooling holes.

9. ELECTRICAL CONNECTIONS

The instrument is provided with screw terminal block to connect cables with a cross section up to 2,5 mm². Before connecting cables make sure the power supply complies with the instrument's requirements. Separate the probe cables from the outputs and the power connections. Do not exceed the maximum current allowed on each relay, in case of heavier loads use a suitable external relay.

9.1 PROBE CONNECTION

The probes shall be mounted with the bulb upwards to prevent damages due to casual liquid infiltration.

10. HOW TO USE THE HOT KEY

10.1 HOW TO PROGRAM A HOT KEY FROM THE INSTRUMENT (UPLOAD)

1. Program one controller with the front keypad.
2. When the controller is ON, insert the "Hot key" and push ▲ key; the "uPL" message appears followed a by flashing "End"
3. Push "SET" key and the End will stop flashing.
4. Turn OFF the instrument remove the "Hot Key", then turn it ON again.

NOTE: the "Err" message is displayed for failed programming. In this case push again ▲ key if you want to restart the upload again or remove the "Hot key" to abort the operation.

10.2 HOW TO PROGRAM AN INSTRUMENT USING A HOT KEY (DOWNLOAD)

1. Turn OFF the instrument.
2. Insert a programmed "Hot Key" into the 5 PIN receptacle and then turn the Controller ON.
3. Automatically the parameter list of the "Hot Key" is downloaded into the Controller memory, the "doL" message is blinking followed a by flashing "End".
4. After 10 seconds the instrument will restart working with the new parameters.
5. Remove the "Hot Key"..

NOTE the message "Err" is displayed for failed programming. In this case turn the unit off and then on if you want to restart the download again or remove the "Hot key" to abort the operation.

11. ALARM SIGNALS

Message	Cause	Output
"EE"	Data or memory failure	
"P1"	Probe failure	Output according to par. "Con" and "COF"
"HA"	Maximum temp. alarm	Output unchanged.
"LA"	Minimum temp. alarm	Output unchanged.

11.1 ALARM "EE"

The instrument is provided with an internal check verifying memory integrity. Alarm "EE" flashes when a failure in the internal memory is detected. In such case call the service.

11.2 ALARM RECOVERY

Probe alarm "P1" start some seconds after the fault in the related probe; it automatically stops some seconds after the probe restarts normal operation. Check connections before replacing the probe.

Temperature alarms "HA" and "LA" automatically stop as soon as the thermostat temperature returns to normal values and when defrost starts.

12. TECHNICAL DATA

Case: frontal 32x74 mm; depth 60mm;

Mounting: panel mounting in a 71x29 mm panel cut-out

Frontal protection: IP65

Connections: Screw terminal block ≤ 2,5 mm² wiring.

Power supply: 12Vac/dc, ±10%

(optional 230, 110, ±10%, 50/60Hz)

Power absorption: 3VA max

Display: 3 digits, red LED, 14,2 mm high.

Inputs: 1 PTC or NTC probe.

Relay outputs

compressor

SPST relay 8(3) A, 250Vac or

SPST relay 20(8)A; 250Vac

agitator

SPDT relay 8(3) A, 250Vac or

Kind of action: 1B.

Pollution grade: normal

Software class: A.

Data storing: on the non-volatile memory (EEPROM).

Operating temperature: 0÷60 °C.

Storage temperature: -30÷85 °C.

Relative humidity: 20÷85% (no condensing)

Measuring and regulation range:

PTC probe: -50÷150°C (-58÷302°F)

NTC probe: -40÷110°C (-58÷230°F)

Resolution: 0,1 °C or 1°C or 1 °F (selectable).

Accuracy (ambient temp. 25°C): ±0,7 °C ±1 digit

13. CONNECTIONS

13.1 XR80C: COMPRESSOR 8A

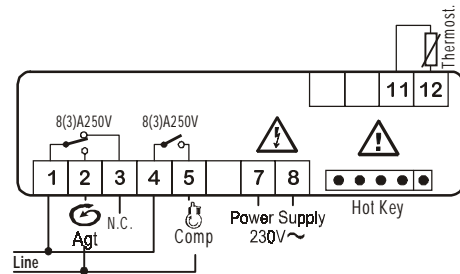

12Vac/dc supply: connect to the terminals 7 and 8.

24Vac/dc supply: connect to the terminals 7 and 8.

120Vac supply: connect to the terminals 7 and 8.

13.2 XR80C: COMPRESSOR 20A

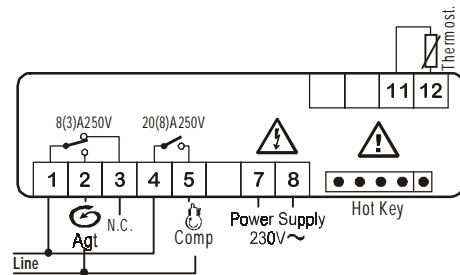

12Vac/dc supply: connect to the terminals 7 and 8.

24Vac/dc supply: connect to the terminals 7 and 8.

120Vac supply: connect to the terminals 7 and 8.

14. DEFAULT SETTING VALUES

Label	Name	Range	Values
Set	Set point	LS÷US	2.0
Hy	Differential	0,1+25.5°C/ 1+ 255°F	2.0
LS	Minimum set point	-50°C÷SET/-58°F÷SET	-30.0
US	Maximum set point	SET+150°C/ SET + 302°F	20.0
Ot	Thermostat probe calibration	-12÷ 12°C / -120 ÷ 120°F	0.0
OdS	Outputs delay at start up	0÷255 min	0
AC	Anti-short cycle delay	0 ÷ 50 min	1
CO _n	Compressor ON time with faulty probe	0 ÷ 255 min	15
CO _F	Compressor OFF time with faulty probe	0 ÷ 255 min	30
CF	Temperature measurement unit	°C ÷ °F	°C
rES	Resolution	in ÷ dE	dE
AgC	Agitator configuration	EL=with compressor; in=independent	EL
tIC	Resolution for the Agt parameter	nP=minutes; Pb=seconds	nP
IAG	Interval between agitation cycle	1÷120min	15
Agt	Length for agitation cycle	0÷255min	3
APO	First agitation cycle after start up	y=immediately; n=after IAG	n
ALc	Temperat. alarms configuration	rE; Ab	Ab
ALU	MAXIMUM temperature alarm	ALL+150.0°C; ALL ÷302°F	100
ALL	Minimum temperature alarm	-50.0°C+ALU/ -58°F ÷ ALU	-50.0
ALd	Temperature alarm delay	0 ÷ 255 min	15
dAo	Delay of temperature alarm at start up	0 ÷ 23h e 50'	1.3
PbC	Probe selection	Ptc ÷ ntc	ntc/Ptc
rEL	Software release	--	1.2
Ptb	Map code	--	--

Hidden parameters