

# WING

## XW60VS

### 1. GENERAL WARNING

#### 1.1 PLEASE READ BEFORE USING THIS MANUAL

- This manual is part of the product and should be kept near the instrument for easy and quick reference.
- The instrument shall not be used for purposes different from those described hereunder. It cannot be used as a safety device.
- Check the application limits before proceeding.

#### 1.2 SAFETY PRECAUTIONS

- Check the supply voltage is correct before connecting the instrument.
- Do not expose to water or moisture: use the controller only within the operating limits avoiding sudden temperature changes with high atmospheric humidity to prevent formation of condensation
- Warning: disconnect all electrical connections before any kind of maintenance.
- Fit the probe where it is not accessible by the End User. The instrument must not be opened.
- In case of failure or faulty operation send the instrument back to the distributor or to "Dixell s.r.l." (see address) with a detailed description of the fault.
- Consider the maximum current which can be applied to each relay (see Technical Data).
- Ensure that the wires for probes, loads and the power supply are separated and far enough from each other, without crossing or intertwining.
- In case of applications in industrial environments, the use of mains filters (our mod. FT1) in parallel with inductive loads could be useful.

### 2. GENERAL DESCRIPTION



Model **XW60VS**, 100x64 format, is microprocessor based controller suitable for applications on medium or low temperature refrigerating units. It is provided with 3 relay outputs to control compressor, defrost - which can be either electrical or hot gas - and the evaporator fans. It is also provided with 3 NTC or PTC probe inputs, one for temperature control, one to control the defrost end temperature of the evaporator. There is 1 digital input (free contact) configurable by parameter. An output allows the user to programme the parameter list with the "Hot Key".

### 3. CONTROLLING LOADS

#### 3.1 THE COMPRESSOR

The regulation is performed according to the temperature measured by the thermostat probe with a positive differential from the set point: if the temperature increases and reaches set point plus differential the compressor is started and then turned off when the temperature reaches the set point value again. In case of fault in the thermostat probe the start and stop of the compressor are timed through parameters "CO<sub>n</sub>" and "CO<sub>F</sub>".

#### 3.2 FAST FREEZING

When defrost is not in progress, it can be activated the keypad by holding the  key pressed for about 3 seconds. The compressor operates in continuous mode for the time set through the "CC<sub>T</sub>" parameter. The cycle can be terminated before the end of the set time using the same activation key,  for about 3 seconds.

#### 3.3 DEFROST

Two defrost modes are available through the "td<sub>F</sub>" parameter: defrost with electrical heater or hot gas. The defrost interval is control by means of parameter "Ed<sub>F</sub>": (Ed<sub>F</sub>=in) the defrost is made every "td<sub>F</sub>" time, (Ed<sub>F</sub>=Sd) the interval "td<sub>F</sub>" is calculate through Smart Defrost algorithm (only when the compressor is ON).

#### 3.4 CONTROL OF EVAPORATOR FANS





The fan control mode is selected by means of the "Fn<sub>C</sub>" parameter:  
**Fn<sub>C</sub>=C-n** fans will switch ON and OFF with the compressor and **not run** during defrost;  
**Fn<sub>C</sub>=O-n** fans will run continuously, but not during defrost

After defrost, there is a timed fan delay allowing for drip time, set by means of the "Fn<sub>d</sub>" parameter.  
**Fn<sub>C</sub>=C-y** fans will switch ON and OFF with the compressor and **run** during defrost;  
**Fn<sub>C</sub>=O-y** fans will run continuously also during defrost







An additional parameter "FS<sub>T</sub>" provides the setting of temperature, detected by the evaporator probe, above which the fans are always OFF. This can be used to make sure circulation of air only if his temperature is lower than set in "FS<sub>T</sub>".

### 4. KEYBOARD













-  To display and modify target set point; in programming mode it selects a parameter or confirm an operation.  
By holding it pressed for 3s when max or min temperature is displayed it will be erased.
-  To see the max. stored temperature; in programming mode it browses the parameter codes or increases the displayed value. By holding it pressed for 3s the fast freezing cycle is started.
-  To see the min stored temperature; in programming mode it browses the parameter codes or decreases the displayed value.
-  By holding it pressed for 3s the defrost is started.
-  Switch ON and OFF the instrument.

#### KEY COMBINATIONS



-  +  To lock and unlock the keyboard.
-  +  To enter the programming mode.
-  +  To exit the programming mode.

#### 4.1 USE OF LEDS



Each LED function is described in the following table.

LED	MODE	Function
	ON	The compressor is running
	FLASHING	- Programming Phase (flashing with LED  - Anti-short cycle delay enabled
	ON	The fan is running
	FLASHING	Programming Phase (flashing with LED  )
	ON	The defrost is enabled
	FLASHING	Drip time in progress
	ON	The Fast Freezing cycle is enabled
	ON	- ALARM signal - In "Pr2" indicates that the parameter is also present in "Pr1"

#### 4.2 HOW TO SEE THE MIN TEMPERATURE

1. Press and release the  key.
2. The "Lo" message will be displayed followed by the minimum temperature recorded.
3. By pressing the  key or waiting for 5s the normal display will be restored.

#### 4.3 HOW TO SEE THE MAX TEMPERATURE

1. Press and release the  key.
2. The "Hi" message will be displayed followed by the maximum temperature recorded.
3. By pressing the  key or waiting for 5s the normal display will be restored.



#### 4.4 HOW TO RESET THE MAX AND MIN TEMPERATURE RECORDED

To reset the stored temperature, when max or min temperature is displayed :

1. Press SET key until "rST" label starts blinking.

**N.B.** After the installation RESET the temperature stored .

#### 4.5 HOW TO SEE AND MODIFY THE SET POINT



1. Push and immediately release the **SET** key: the display will show the Set point value;
2. The SET LED start blinking;
3. To change the Set value push the  or  arrows within 10s.
4. To memorise the new set point value push the **SET** key again or wait 10s.

#### 4.6 TO START A MANUAL DEFROST

1. Push the **DEF** key for more than 2 seconds and a manual defrost will start.



#### 4.7 TO ENTER IN PARAMETERS LIST "PR1"

To enter the parameter list "Pr1" (user accessible parameters) operate as follows:

1. Enter the Programming mode by pressing the Set and DOWN key for few seconds ( and  start blinking).
2. The instrument will show the first parameter present in "Pr1"

#### 4.8 TO ENTER IN PARAMETERS LIST "PR2"

To access parameters in "Pr2":

1. Enter the "Pr1" level.
2. Select "Pr2" parameter and press the **SET** key.
3. The "PAS" flashing message is displayed, shortly followed by "0 -" with a flashing zero.
4. Use  or  to input the security code in the flashing digit; confirm the figure by pressing **SET**. The security code is "321".
5. If the security code is correct the access to "Pr2" is enabled by pressing **SET** on the last digit.

Another possibility is the following: after switching ON the instrument the user can push Set and DOWN keys within 30 seconds.

**NOTE:** each parameter in "Pr2" can be removed or put into "Pr1" (user level) by pressing "SET" +  $\downarrow$ . When a parameter is present in "Pr1" LED (L) is on.

**4.9 HOW TO CHANGE THE PARAMETER VALUE**

1. Enter the Programming mode.
2. Select the required parameter with  $\uparrow$  or  $\downarrow$ .
3. Press the "SET" key to display its value (L) and LED starts blinking).
4. Use  $\uparrow$  or  $\downarrow$  to change its value.
5. Press "SET" to store the new value and move to the following parameter.

**To exit:** Press SET + UP or wait 15s without pressing a key.

**NOTE:** the new programming is stored even when the procedure is exited by waiting the time-out.

**4.10 HOW TO LOCK THE KEYBOARD**

1. Keep the  $\uparrow$  and  $\downarrow$  keys pressed together for more than 3 s the  $\uparrow$  and  $\downarrow$  keys.
2. The "POF" message will be displayed and the keyboard is locked. At this point it is only possible the viewing of the set point or the MAX or Min temperature stored and to switch ON and OFF the light, the auxiliary output and the instrument.

**TO UNLOCK THE KEYBOARD**

Keep the  $\uparrow$  and  $\downarrow$  keys pressed together for more than 3s.

**4.11 ON/OFF FUNCTION**

By pushing the ON/OFF key, the instrument shows "OFF" for 5 sec. and the ON/OFF LED is switched ON.

During the OFF status, all the relays are switched OFF and the regulations are stopped; **N.B. During the OFF status the Light button is active.**

**4.12 TO SEE THE PROBE VALUES**

1. Enter in "Pr2" level.
2. Select "Prd" parameter with  $\uparrow$  or  $\downarrow$ .
3. Press the "SET" key to display "Pb1" label alternate with Pb1 value.
4. Use  $\uparrow$  and  $\downarrow$  keys to display the other probe values.
5. Press "SET" to move to the following parameter.

**5. PARAMETER LIST**

**REGULATION**

- Hy Differential:** (0,1 $\pm$ 25,5 $^{\circ}$ C; 1 $\pm$ 45 $^{\circ}$ F): Intervention differential for set point, always positive. Compressor Cut IN is Set Point Plus Differential (Hy). Compressor Cut OUT is when the temperature reaches the set point.
- LS Minimum set point limit:** (-50,0 $^{\circ}$ C+SET; -58 $^{\circ}$ F:SET) Sets the minimum acceptable value for the set point.
- US Maximum set point limit:** (SET+110 $^{\circ}$ C; SET $\pm$ 230 $^{\circ}$ F) Set the maximum acceptable value for set point.
- OdS Outputs activation delay at start up:** (0 $\pm$ 255 min) This function is enabled at the initial start up of the instrument and inhibits any output activation for the period of time set in the parameter. (Light can work)
- AC Anti-short cycle delay:** (0 $\pm$ 30 min) interval between the compressor stop and the following restart.
- CCt Thermostat override:** (0min  $\pm$ 23h 50min) allows to set the length of the continuous cycle. Can be used, for instance, when the room is filled with new products.
- Con Compressor ON time with faulty probe:** (0 $\pm$ 255 min) time during which the compressor is active in case of faulty thermostat probe. With CO<sub>n</sub>=0 compressor is always OFF.
- COF Compressor OFF time with faulty probe:** (0 $\pm$ 255 min) time during which the compressor is off in case of faulty thermostat probe. With CO<sub>f</sub>=0 compressor is always active.

**DISPLAY**

- CF Temperature measurement unit:**  $^{\circ}$ C = Celsius;  $^{\circ}$ F = Fahrenheit. When the measurement unit is changed the SET point and the values of some parameters have to be modified.
- rES Resolution (for  $^{\circ}$ C):** (in = 1 $^{\circ}$ C; de = 0,1 $^{\circ}$ C) allows decimal point display.  
dE = 0,1 $^{\circ}$ C; in = 1 $^{\circ}$ C
- Lod Local display:** select which probe is displayed by the instrument:  
P1 = Room probe  
P2 = Evaporator probe  
P3 = Display probe  
1r2 = difference between P1 and P2 (P1-P2)

**DEFROST**

- tdF Defrost type:**  
rE = electrical heater (Compressor OFF)  
in = hot gas (Compressor and defrost relays ON)
- EdF Defrost mode:**  
in = interval mode. The defrost starts when the time "ldf" is expired.  
Sd = Smartfrost mode. The time ldf (interval between defrosts) is increased only when the compressor is running (even non consecutively).
- SdF Set point for SMARTFROST:** (-30 $\pm$ 30  $^{\circ}$ C/ -22 $\pm$ 86  $^{\circ}$ F) evaporator temperature which allows the ldf counting (interval between defrosts) in SMARTFROST mode.
- dtE Defrost termination temperature:** (-50,0 $\pm$ 110,0 $^{\circ}$ C; -58 $\pm$ 230 $^{\circ}$ F) (Enabled only when the evaporator probe is present) sets the temperature measured by the evaporator probe which causes the end of defrost.
- ldF Interval between defrosts:** (1 $\pm$ 120h) Determines the time interval between the beginning of two defrost cycles.
- MdF (Maximum) duration of defrost:** (0 $\pm$ 255 min) When P2P = n, no evaporator probe, it sets the defrost duration, when P2P = y, defrost end based on temperature, it sets the maximum length for defrost.
- dFd Display during defrost:**  
rt = real temperature; it = temperature reading at the defrost start;  
Set = set point; dEF = "dEF" label; dEG = "dEG" label;
- dAd Defrost display time out:** (0 $\pm$ 255 min) Sets the maximum time between the end of defrost and the restarting of the real room temperature display.

- dSd Start defrost delay:** (0 $\pm$ 99min) This is useful when different defrost start times are necessary to avoid overloading the plant.
- Fdt Drain down time:** (0 $\pm$ 60 min.) time interval between reaching defrost termination temperature and the restoring of the control's normal operation. This time allows the evaporator to eliminate water drops that might have formed due to defrost.
- dPO First defrost after start-up:**  
y = Immediately; n = after the ldf time
- dAF Defrost delay after fast freezing:** (0min $\pm$ 23h 50min) after a Fast Freezing cycle, the first defrost will be delayed for this time.

**FANS**

- FnC Fan operating mode:**  
C-n = running with the compressor, OFF during the defrost;  
C-y = running with the compressor, ON during the defrost;  
O-n = continuous mode, OFF during the defrost;  
O-y = continuous mode, ON during the defrost;
- FnD Fan delay after defrost:** (0 $\pm$ 255 min) The time interval between the defrost end and evaporator fans start.
- FSt Fan stop temperature:** (-50 $\pm$ 110 $^{\circ}$ C; -58 $\pm$ 230 $^{\circ}$ F) setting of temperature, detected by evaporator probe, above which the fan is always OFF.

**ALARMS**

- ALC Temperature alarm configuration**  
rE = High and Low alarms related to Set Point  
Ab = High and low alarms related to the absolute temperature.
- ALU High temperature alarm setting:**  
ALC= rE, 0  $\pm$  50 $^{\circ}$ C or 90 $^{\circ}$ F  
ALC= Ab, ALL  $\pm$  110 $^{\circ}$ C or 230 $^{\circ}$ F  
when this temperature is reached and after the ALd delay time the HA alarm is enabled.
- ALL Low temperature alarm setting:**  
ALC = rE , 0  $\pm$  50  $^{\circ}$ C or 90 $^{\circ}$ F  
ALC = Ab , - 50 $^{\circ}$ C or -58 $^{\circ}$ F  $\pm$  ALU  
when this temperature is reached and after the ALd delay time, the LA alarm is enabled..
- AFH Temperature alarm and fan differential:** (0,1 $\pm$ 25,5 $^{\circ}$ C; 1 $\pm$ 45 $^{\circ}$ F) Intervention differential for temperature alarm set point and fan regulation set point, always positive.
- ALd Temperature alarm delay:** (0 $\pm$ 255 min) time interval between the detection of an alarm condition and the corresponding alarm signalling.
- dAO Delay of temperature alarm at start-up:** (0min $\pm$ 23h 50min) time interval between the detection of the temperature alarm condition after the instrument power on and the alarm signalling.
- EdA Alarm delay at the end of defrost:** (0 $\pm$ 255 min) Time interval between the detection of the temperature alarm condition at the end of defrost and the alarm signalling.
- doA Open door alarm delay:**(0 $\pm$ 255 min) delay between the detection of the open door condition and its alarm signalling: the flashing message "dA" is displayed.
- nPS Pressure switch number:** (0  $\pm$ 15) Number of activation of the pressure switch, during the "did" interval, before signalling the alarm event (I2F= PAL).  
**If the nPS activation in the did time is reached, switch off and on the instrument to restart normal regulation.**

**PROBE INPUTS**

- Ot Thermostat probe calibration:** (-12,0 $\pm$ 12,0 $^{\circ}$ C/ -21 $\pm$ 21 $^{\circ}$ F) allows to adjust possible offset of the thermostat probe.
- OE Evaporator probe calibration:** (-12,0 $\pm$ 12,0 $^{\circ}$ C/ -21 $\pm$ 21 $^{\circ}$ F) allows to adjust possible offsets of the evaporator probe.
- O3 Display probe calibration:** (-12,0 $\pm$ 12,0 $^{\circ}$ C/ -21 $\pm$ 21 $^{\circ}$ F) allows to adjust possible offsets of the display probe.
- P2P Evaporator probe presence:** n= not present; the defrost stops only by time; y= present: the defrost stops by temperature and time.
- P3P Display probe presence:** n= not present; y= present.
- HES Temperature increase during the Energy Saving cycle:** (-30,0 $^{\circ}$ C  $\div$  30,0 $^{\circ}$ C / -22 $\pm$ 86 $^{\circ}$ F) sets the increasing value of the set point during the Energy Saving cycle.

**DIGITAL INPUTS**

- odc Compressor and fan status when open door:**  
no = normal; Fan = Fan OFF; CPr = Compressor OFF; F\_C = Compressor and fan OFF.
- I2P Configurable digital input polarity:**  
CL : the digital input is activated by closing the contact;  
OP : the digital input is activated by opening the contact
- I2F Digital input operating mode:** configure the digital input function:  
EAL = generic alarm; bAL = serious alarm mode; PAL = Pressure switch; dFr = Start defrost;  
AUS = Not used; Es = Energy Saving; onF = remote On/OFF; dor = door switch
- did Time interval/delay for digital input alarm:**(0 $\pm$ 255 min.) If I2F=EAL or bAL (external alarms), "did" parameter defines the time delay between the detection and the successive signalling of the alarm.

**OTHER**

- Adr RS485 serial address (1 $\pm$ 247):** Identifies the instrument address when connected to a ModBUS compatible monitoring system.
- PbC Type of probe:** it allows to set the kind of probe used by the instrument:  
PbC = PBC probe, nTC = NTC probe.
- rEL Release software:** (read only) Software version of the microprocessor.
- Ptb Parameter table:** (read only) it shows the original code of the dixell parameter map.
- Prd Probes display:** (read only) display the temperature values of the evaporator probe Pb2.
- Pr2 Access to the protected parameter list** (read only).

**6. DIGITAL INPUT**

The XW60VS has 1 free contact digital input. It is programmable in seven different configurations by the "I2F" parameter.

**6.1 DOOR SWITCH INPUT (I2F = dor)**

It signals the door status and the corresponding relay output status through the "odc" parameter:

- no = normal (any change);
- Fan = Fan OFF;
- CPr = Compressor OFF;
- F\_C = Compressor and fan OFF.

Since the door is opened, after the delay time set through parameter "dOA", the alarm output is enabled and the display shows the message "dA". The alarm stops as soon as the external digital input is disabled again.

During this time and then for the delay "dot" after closing the door, the high and low temperature alarms are disabled.

**6.2 GENERIC ALARM (I2F = EAL)**

As soon as the digital input is activated the unit will wait for "did" time delay before signalling the "EAL" alarm message. The outputs status don't change. The alarm stops just after the digital input is de-activated.

**6.3 SERIOUS ALARM MODE (I2F = BAL)**

When the digital input is activated, the unit will wait for "did" delay before signalling the "BAL" alarm message. The relay outputs are switched OFF. The alarm will stop as soon as the digital input is de-activated.

**6.4 PRESSURE SWITCH (I2F = PAL)**

If during the interval time set by "did" parameter, the pressure switch has reached the number of activation of the "nPS" parameter, the "PAL" pressure alarm message will be displayed. The compressor and the regulation are stopped. When the digital input is ON the compressor is always OFF.

**If the nPS activation in the did time is reached, switch off and on the instrument to restart normal regulation.**

**6.5 START DEFROST (I2F = DFR)**

It executes a defrost if there are the right conditions. After the defrost is finished, the normal regulation will restart only if the digital input is disabled otherwise the instrument will wait until the "Mdf" safety time is expired.

**6.6 ENERGY SAVING (I2F = ES)**

The Energy Saving function allows to change the set point value as the result of the SET+ HES (parameter) sum. This function is enabled until the digital input is activated.

**6.7 REMOTE ON/OFF (I2F = ONF)**

This function allows to switch ON and OFF the instrument.

**6.8 DIGITAL INPUTS POLARITY**

The digital input polarity depends on the "I2P" parameters.  
**CL** : the digital input is activated by closing the contact.  
**OP** : the digital input is activated by opening the contact

**7. INSTALLATION AND MOUNTING**

Instruments XW60VS shall be mounted on vertical panel, in a 72x56 mm hole, and fixed using screws  $\varnothing$  3 x 2mm. To obtain an IP65 protection grade use the front panel rubber gasket (mod. RGW-V).

The temperature range allowed for correct operation is 0 - 60 °C (32±120°F). Avoid places subject to strong vibrations, corrosive gases, excessive dirt or humidity. The same recommendations apply to probes. Let the air circulate by the cooling holes.

**7.1 XW60VS: CUT OUT**

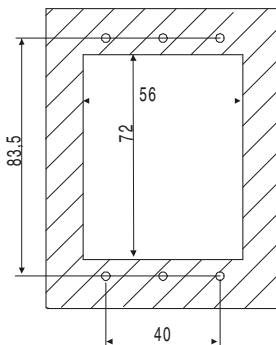

**8. ELECTRICAL CONNECTIONS**

The instrument is provided with faston connections (6,3mm). Heat-resistant cables have to be used. Before connecting cables make sure the power supply complies with the instrument's requirements. Separate the probe cables from the power supply cables, from the outputs and the power connections. Do not exceed the maximum current allowed on each relay, in case of heavier loads use a suitable external relay.  
**N.B.** Maximum current allowed for all the loads is 20A.

**8.1 PROBE CONNECTIONS**

The probes shall be mounted with the bulb upwards to prevent damages due to casual liquid infiltration. It is recommended to place the thermostat probe away from air streams to correctly measure the average room temperature. Place the defrost termination probe among the evaporator fins in the coldest place, where most ice is formed, far from heaters or from the warmest place during defrost, to prevent premature defrost termination.

**9. USE OF THE PROGRAMMING "HOT KEY"**

The XW60VS unit can UPLOAD or DOWNLOAD the parameter list from its own E2 internal memory to the "Hot Key" and vice-versa.

**Note:** You must first program one controller with the front keypad. Double check the parameters that you want to duplicate. Label the HOT KEY with a code for that program.

**9.1 UPLOAD (FROM THE INSTRUMENT TO THE "HOT KEY")**

1. When the Controller is ON, insert the "Hot key" and push UP key; the "uPL" message appears followed by flashing "End"
2. Push "SET" key and the End will stop flashing;
3. Turn OFF the instrument remove the "Hot Key", then turn it ON again.

(At the end of the data transfer phase the instrument displays the following messages:)

"End" for right programming.

"Err" for failed programming. In this case push "SET" key if you want to restart the programming again or remove the not programmed "Hot key".

**9.2 DOWNLOAD (FROM THE "HOT KEY" TO THE INSTRUMENT)**

1. Turn OFF the instrument by means of the ON/OFF key (or un-plug the appliance), insert the "Hot Key" into the 5 PIN receptacle and then turn the Controller ON.
2. Automatically the parameter list of the "Hot Key" is downloaded into the Controller memory, the "DoL" message is blinking. After 10 seconds the instrument will restart working with the new parameters.
3. Turn OFF the instrument remove the "Hot Key", then turn it ON again.

At the end of the data transfer phase the instrument displays the following messages:  
 "End" for right programming. The instrument starts regularly with the new programming.  
 "Err" for failed programming. In this case turn the unit off and then on if you want to restart the download again or remove the "Hot key" to abort the operation.

**10. ALARM SIGNALS**

Message	Cause	Outputs
"P1"	Thermostat probe failure	Alarm output ON; Compressor output according to parameters "CO <sub>n</sub> " and "CO <sub>F</sub> "
"P2"	Evaporator probe failure	Alarm output ON; Other outputs unchanged
"P3"	Display probe failure	Alarm output ON; Other outputs unchanged
"HA"	Maximum temperature alarm	Alarm output ON; Other outputs unchanged
"LA"	Minimum temperature alarm	Alarm output ON; Other outputs unchanged
"EE"	Data or memory failure	Alarm output ON; Other outputs unchanged
"dA"	Door switch alarm	Alarm output ON; Other outputs unchanged
"EAL"	External alarm	Alarm output ON; Other outputs unchanged
"bAL"	Serious external alarm	Alarm output ON; Other outputs OFF
"PAL"	Pressure switch alarm	Alarm output ON; Other outputs OFF

The alarm message is displayed until the alarm condition is recovery.  
 All the alarm messages are showed alternating with the room temperature except for the "P1" which is flashing. To reset the "EE" alarm and restart the normal functioning press any key, the "rSt" message is displayed for about 3s.

**10.1 "EE" ALARM**

The dixell instruments are provided with an internal check for the data integrity. Alarm "EE" flashes when a failure in the memory data occurs. In such cases the alarm output is enabled.

**10.2 ALARM RECOVERY**

**Probe alarms** : "P1" (probe1 faulty), "P2" and "P3"; they automatically stop 10s after the probe restarts normal operation. Check connections before replacing the probe.  
**Temperature alarms** "HA" and "LA" automatically stop as soon as the thermostat temperature returns to normal values or when the defrost starts.  
**Door switch alarm** "dA" stop as soon as the door is closed.  
**External alarms** "EAL", "BAL" stop as soon as the external digital input is disabled  
**Pressure switch alarm** "PAL" alarm is recovered by switching OFF the instrument.

**11. TECHNICAL DATA**

**Housing**: self extinguishing ABS.  
**Case**: facia 100x64 mm; depth 40mm  
**Mounting** : panel mounting in a 56x72 mm panel cut-out with two screws.  $\varnothing$  3x2mm. Distance between the holes 40mm  
**Protection**: IP20.  
**Frontal protection**: IP65 with optional frontal gasket; RGW-V (XW60VS).  
**Connections**: heat-resistant wiring and 6,3mm Faston for loads and power supply  
**Power supply**: 230Vac  $\pm$  10% or 120Vac or 24Vac  
**Power absorption**: 3VA max.  
**Display**: 3 digits, red LED, 14,2 mm high.  
**Inputs**: 3 NTC or PTC probes  
**Digital input**: 1 free voltage  
**Relay outputs**: Total current on loads MAX. 10A  
     compressor: relay SPST 16(6) A, 250Vac  
     fans: relay SPST 8(3) A, 250Vac  
     defrost: relay SPDT 16(6) A, 250Vac  
**Data storing**: on the non-volatile memory (EEPROM).  
**Kind of action**: 1B.  
**Pollution grade**: normal  
**Software class**: A.  
**Operating temperature**: 0÷60 °C.  
**Storage temperature**: -25÷60 °C.  
**Relative humidity**: 20÷85% (no condensing)  
**Measuring and regulation range**:  
     PTC probe: -50÷150°C (-58÷302°F)  
     NTC probe: -40÷110°C (-58÷230°F)  
**Resolution**: 0,1 °C or 1°C or 1 °F (selectable).  
**Accuracy (ambient temp. 25°C)**:  $\pm$ 0,5 °C  $\pm$ 1 digit

12. CONNECTIONS

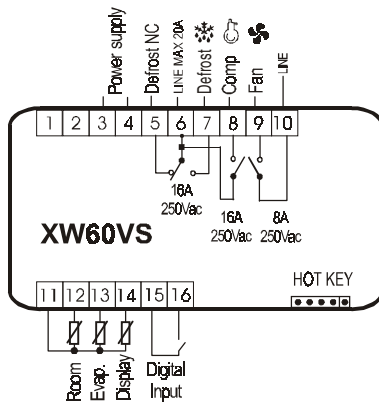

Power supply: use terminal 3-4; according to the model 230Vac or 120Vac or 24Vac

13. DEFAULT SETTING VALUES

Label	Name	Range	Default	Level
<b>REGULATION</b>				
Set	Set point	LS:US	-5.0	---
Hy	Differential	0,1:25,5 °C / 1:45°F	2.0	Pr1
LS	Minimum set point	-50,0°C:SET / -58°F:SET	-30.0	Pr2
US	Maximum set point	SET ÷ 110°C / SET ÷ 230°F	20.0	Pr2
Ods	Outputs activation delay at start up	0:255 min.	0	Pr2
AC	Anti-short cycle delay	0:30 min.	1	Pr1
CCt	Compressor ON time during fast freezing	0 ÷ 23h 50 min.	0.0	Pr2
COon	Compressor ON time with faulty probe	0:255 min.	15	Pr2
COF	Compressor OFF time with faulty probe	0:255 min.	30	Pr2
<b>DISPLAY</b>				
CF	Temperature measurement unit	°C ± °F	°C	Pr2
rES	Resolution (integer/decimal point)	in ÷ de	dE	Pr1
Lod	Local display	P1 ÷ 1r2	P1	Pr2
<b>DEFROST</b>				
tdF	Defrost type	rE, rT, in	rE	Pr2
EdF	Defrost mode	in, Sd	in	Pr2
SdF	Set point for SMART DEFROST	-30 ÷ +30°C / -22 ÷ +86°F	0	Pr2
dtE	Defrost termination temperature	-50,0:110°C / -58:230°F	8.0	Pr1
IdF	Interval between defrost cycles	1:120h	6	Pr1
MdF	(Maximum) length for 1° defrost	0:255 min.	30	Pr1
dFd	Displaying during defrost	rt, it, SEt, dEF, dEG	it	Pr2
dAd	MAX display delay after defrost	0:255 min.	30	Pr2
dSd	Delay before defrost	0:255 min.	0	Pr2
Fdt	Draining time	0:60 min.	0	Pr2
dPO	First defrost after start up	n ÷ y	n	Pr2
dAF	Defrost delay after fast freezing	0 ÷ 23h 50 min.	0.0	Pr2
<b>FANS</b>				
FnC	Fans operating mode	C-n, C-y, O-n, O-y	O-n	Pr2
Fnd	Fans delay after defrost	0:255 min.	10	Pr2
FSt	Fans stop temperature	-50,0:110°C / -58:230°F	2.0	Pr2
<b>ALARMS</b>				
ALC	Temperature alarms configuration	rE:Ab	Ab	Pr2
ALU	MAXIMUM temperature alarm	-50,0:110°C / -58:230°F	110	Pr1
ALL	minimum temperature alarm	-50,0:110°C / -58:230°F	-40.0	Pr1
AFH	Temperature alarm differential	0,1:25,5 °C / 1:45°F	2.0	Pr2
ALd	Temperature alarm delay	0:255 min.	15	Pr2
dAO	Delay of temperature alarm at start up	0 ÷ 23h 50 min.	1.3	Pr2
EdA	Alarm delay at the end of defrost	0:255 min.	30	Pr2
dot	Delay of temperature alarm after closing the door	0:255 min.	15	Pr2
dOA	Open door alarm delay	0:255 min.	15	Pr2
nPS	Pressure switch number	0:15	0	Pr2
<b>ANALOGUE INPUTS</b>				
Ot	Thermostat probe calibration	-12,0:12,0°C / -21:21°F	0	Pr1
OE	Evaporator probe calibration	-12,0:12,0°C / -21:21°F	0	Pr1
O3	Display probe calibration	-12,0:12,0°C / -21:21°F	0	Pr1
P2P	Evaporator probe presence	n ÷ y	y	Pr2
P3P	Display probe presence	n ÷ y	y	Pr2
HES	Temperature increasing during the Energy Saving cycle	-30:30°F / -54:54°F	0	Pr2
<b>DIGITAL INPUTS</b>				
Odc	Open door control	no, Fan, CPt, F_C	FAn	Pr2
i2P	Configurable digital input polarity	CL:OP	cL	Pr2
i2F	Digital input configuration	dor, EAL, bAL, PAL, dFr, AUS, ES, OnF	dor	Pr2
dId	Digital input alarm delay	0:255 min.	5	Pr2
<b>OTHER</b>				
Adr	Serial address	0:247	1	Pr2
Pbc	Kind of probe	PbC, ntc	ntc	Pr2
rEL	Software release	---	2.0	Pr2
Ptb	Map code	---	---	Pr2
Prd	Probes display	Pb1: Pb3	---	Pr2
Pr2	Access parameter list	---	---	Pr1

Dixell s.r.l. Via dell'Industria, 27  
 32010 Z.I. Pieve d'Alpago (BL) ITALY  
 tel. +39 - 0437 - 98 33 - fax +39 - 0437 - 98 93 13  
 E-mail: dixell@dixell.com - http://www.dixell.com