

AT2-5

Thank you for having chosen an LAE electronic product. Before installing the instrument, please read this instruction booklet carefully in order to ensure safe installation and optimum performance.

1. INSTALLATION

1.1 The AT2-5, size 77x35x77 mm (WxHxD), is inserted into the panel through a hole measuring 71x29 mm and is fixed by means of the suitable clips, by pressing gently. If fitted, check that the rubber gasket adheres to the panel perfectly, in order to prevent debris and moisture infiltration to the back of the instrument.

1.2 The instrument should work with room temperatures between -10°.. +50°C and relative humidity between 15%.. 80% inclusive. Supply voltage, switched powers and connection set-up should scrupulously comply with the indications given on the container. To reduce the effects of electromagnetic disturbance, keep the sensor and signal cables well separate from the power wires.

1.3 The sensor T1 measures the air temperature and activates in the thermostat control cycle; it should be placed inside the appliance in a point that truly represents the temperature of the stored product. If fitted and enabled, (T2=YES), the sensor T2 measures the evaporator temperature, and should be placed where there is the maximum formation of frost.

CAUTION: should the relays have to switch a heavy load frequently, it is advisable to contact the manufacturer for indications on the lifetime of the contacts.

Whenever products must be kept within very severe specifications or the products have considerable value, the use of a second instrument is recommended, which activates upon or warns of any malfunction

2. OPERATING MODES

Upon switching on, just the central line (autotest) appears on the display for approximately three seconds and the subsequent indications depend on the operating status of the controller. TABLE 1 gives the indications associated with the various states, whereas the symbols appearing below are explained in TABLE 2.

STANDBY	NORMAL	INFO MENU	INFO DATA	SETUP MENU	PARAMETER VALUE
OFF Not Operating	-19 Product Temper. (sim.)	T1 Air temperature	→ -20	SCL Display scale	→ 1°C
	DEF Defrost	T2 Evaporator temperature	→ -25	SPL Minimum setpoint	→ -25
	REC Recovery after defrost	→ ...	SPH Maximum setpoint	→ -18
	HI High temp. alarm	TLO Min. stored temperature	→ -19	...	→ ...
	...	CND Condenser clean cycle	→ 15	...	→ ...
	E1 Faulty T1 probe	LOC Locked keypad	→ NO	...	→ ...

TABLE 1

2.1 STANDBY. If button is pressed for 3 seconds, it allows the AT2 to be put on a standby, or to resume output control (with parameter **SB**=YES only). An indication on the display shows that the outputs are off permanently.

2.2 NORMAL. During normal operation, the display shows the temperature measured by probe T1, presented in the most appropriate manner. Through parameter **SCL** you select the display range according to the table below:

SCL	1°C (only with INP=SN4)	2°C	°F
RANGE	-50/-9.9.. +19.9/+80	-50.. +120	-55.. +240

The temperature measured by probe T1 may be corrected with a fixed offset by assigning a value other than 0 to the parameter **OS1**. Also probe T2

may be corrected with a fixed offset, in this case parameter **OS2**. Additionally, prior to display, the temperature is treated by an algorithm that allows the simulation of a thermal mass directly proportional to the **SIM** value. The result is a reduction in the fluctuation of the displayed value.

2.3 INFO MENU. Pressing the button **[i]** and releasing it immediately activates the information selection menu. From this menu you can display the instantaneous temperatures T1 and T2; the maximum (THI) and minimum (TLO) stored temperature; the total operating time of the condenser since its last cleaning (CND) and the keypad status (LOC). The information to be displayed can be selected sequentially, by pressing **[i]** repeatedly or quickly via the buttons **[v]** and **[a]** to scroll through the menu. Exit from the info menu is by pressing button **[x]** or automatic after 6 seconds of not using the keypad.

In the INFO operating mode it's also possible to reset the recordings THI and TLO and the hour counter CND by pressing buttons **[i]** + **[x]** simultaneously while the value is displayed.

2.4 SETPOINT. The setpoint value is displayed by keeping the button **[i]** pressed for at least half second. The value is programmed by pressing buttons **[i]** + **[v]** or **[a]** within the minimum limit **SPL** and the maximum limit **SPH**. When the button is released, the newly programmed value is stored. The actual setpoint, minimum and maximum setpoint limits depend on the selection **I/II** active when the operation is performed.

2.5 KEYPAD LOCK. The keypad lock avoids undesired, potentially dangerous operations, which might be attempted when the controller is operating in a public place. In the INFO mode, through the buttons **[v]** and **[a]** it's possible to assign YES or NO to the parameter **LOC**. With LOC=YES all keypad commands are inhibited. To resume normal operation of keypad, adjust setting so that LOC=NO.

2.6 DEFROSTING. By assigning a value greater than 0 to the parameter **DDY**, during defrost the indication **[DEF]** is displayed instead of the temperature. In this case, after defrost and for the time programmed in DDY, the display indication **[REC]** shows that the normal thermostatic cycle is being resumed.

2.7 ALARM. An anomaly in the operation is displayed through the lighting up of an abbreviation showing its cause: **[HI]/[LO]** high/low alarm temperature in the cabinet, **[DO]** door open, **[C]** periodic condenser cleaning, **[E1]/[E2]**, fault of probe T1 / T2.

2.8 SETUP. The setup is accessed by pressing the buttons **[v]** + **[i]** in succession and keeping them pressed simultaneously for 5 seconds. The available parameters appear in TABLE 2 as shown below.

3. CONFIGURATION

The controller is configured for the system to be controlled by programming the operating parameters, that is, through the setup (see par. 2.8). In SETUP, press button **[a]** to pass from one parameter to the next, and press button **[v]** to go back. To display the value of a parameter press **[i]**, to modify it press buttons **[i]** + **[v]** or **[a]** simultaneously. Exit from the setup is by pressing button **[x]** or automatic after 30 seconds of not using the keypad.

Par.	Adjustment	Function	Sect.
SCL	1°C/2°C/°F	Readout scale	2.2
SPL	-50.. SPH [°]	Minimum temperature set point	2.4
SPH	SPL.. +120 [°]	Maximum temperature set point	2.4
SP	SPL.. SPH [°]	Effective temperature set point	4.1
C-H	REF/HEA	Refrigerating/Heating selection	4.1
HYS	+1.. +100 [°]	Thermostat hysteresis	4.1
CRT	0.. 30 [min]	Compressor rest time	4.1
CT1	0.. 30 [min]	Compressor run with sensor T1 failure	4.2
CT2	0.. 30 [min]	Compressor stop with sensor T1 failure	4.2
CSD	0.. 30 [min]	Compressor stop delay from door opening	4.3
DFR	0.. 24	Defrosting frequency /24h	5.1
DLI	-50.. +120 [°]	Defrost end temperature	5.3
DTO	1.. 120 [min]	Maximum defrosting duration	5.3
DTY	OFF/ELE/GAS	Defrost type	5.2
DRN	0.. 30 [min]	Drain down time	5.3
DDY	0.. 60 [min]	Defrosting display control	2.6
FID	YES/NO	Fans active during defrost	6.3
FDD	-50.. +120 [°]	Fan re-start delay temperature	6.4
FTC	YES/NO	Evaporator fan timed control	6.1
FT1	0.. 180 [sec]	Fan stop delay	6.1
FT2	0.. 30 [min]	Timed fan stop	6.1
FT3	0.. 30 [min]	Timed fan run	6.1
ATM	NON/ABS/REL	Alarm threshold control	7.1

Par.	Adjustment	Function	Sect.
ALA(R) ¹⁾	-50... +120 (-120.. 0)	Low alarm (differential) temperature	7.1
AHA(R) ¹⁾	-50... +120 (0.. +120)	High alarm (differential) temperature	7.1
ATD ²⁾	0.. 120 [min]	Alarm temperature delay	7.1
ADO	0.. 30 [min]	Door alarm delay	7.2
ACC	0.. 52 [weeks]	Periodic condenser cleaning	7.3
IISM	NON/MAN	2nd set switching mode	9.1
IISL ²⁾	-50.. IISH [°]	Minimum 2nd temperature set	2.4
IISH ²⁾	IISL.. +120 [°]	Maximum 2nd temperature set	2.4
IISP ²⁾	IISL.. IISH [°]	Effective 2nd temperature set	4.1
IIHY ²⁾	+1.. +100 [°]	Hysteresis of 2nd temperature set	4.1
IIFT ²⁾	YES/NO	Evaporator fan timed control in mode 2	6.1
IIDF ²⁾	0.. 24	Defrosting frequency /24h in mode 2	5.1
SB	YES/NO	Button [v] enabling	2.1
DS	YES/NO	Door switch enabling	6.2
LSM	NON/MAN/DOR	Light control mode	9.3
OAU	NON/0-1/DEF/LGT/ALO/ALI	AUX output control	9.3
INP	SN4/ST1	NTC/PTC probe selection	9.2
OS1	-125.. +125 [°]	Probe T1 offset	2.2
T2	YES/NO	Probe T2 enabling	1.3
OS2	-125.. +125 [°]	Probe T2 offset	2.2
TLD	1.. 30 [min]	Delay for min./max. temperature storage	8
SIM	0.. 100	Display slowdown	2.2
ADR	1.. 255	01 - Don't change	--

TABLE 2

1) Active exclusively with ATM=ABS (ALA and AHA) or with ATM=REL (ALR and AHR).

2) Active exclusively with IISM=MAN.

***CAUTION:** upon changing the display scale SCL, it is **ESSENTIAL** to reconfigure the parameters related to the absolute (SPL, SPH, SP, etc.) and differential (HYS, ALR, AHR, etc) temperatures.

4. THERMOSTAT CONTROL

4.1 Thermostat control is based on comparing the temperature T1, the set point ***SP** and the hysteresis ***HYS**, in the control mode determined by parameter **C-H**. With C-H you choose refrigerating (REF) or heating (HEA) control mode. In order to understand control modes better, please read the following example:

C-H=REF: with SP=2.0 and HYS=1.5, the compressor will be Off with T1= +2.0° and On with T1= +3.5° (2+1.5).

C-H=HEA: with SP=75 and HYS=3, the heater will be Off with T1= +75° and On with T1=72° (75-3).

The output only switches On again if the Off time period determined by **CRT** since the previous switchover has elapsed. Whenever a very small hysteresis HYS must be maintained, it is advised that a suitable value for CRT is selected in order to reduce the number of starts per hour.

4.2 If sensor T1 fails, the output is controlled by parameters **CT1** and **CT2** giving fixed On and Off times of the output.

Example: CT1=06, CT2=4, 6 minutes On, 4 minutes Off.

4.3 If door switch input control has been enabled (DS=YES), parameter **CSD** determines the delay between when the door is opened and the compressor (heater) stopping.

* Actual setpoint and hysteresis depend on the selection I/II: in mode **I**, the reference parameters are **SP** and **HYS** while in mode **II**, **IISP** and **IIHY**.

5. DEFROSTING

5.1 Defrosting starts automatically when necessary time has elapsed to obtain the defrosting frequency set with ***DFR**. For example, with DFR=4 defrosting occurs once every 6 hours. The internal timer is set to zero at the power-up and at each subsequent defrost start. When the controller is put on a standby, the accumulated time count is "frozen" (is not incremented).

Defrosting may also be induced manually by keeping the button  pressed for 2 seconds.

With **C-H=HEA**, all defrost functions are inhibited; differently, with DFR=0, timed defrost only is removed, while manual defrost remains active.

5.2 Once defrost has started, the compressor and defrost outputs are controlled according to parameter **DTY** and **OAU**.

As a matter of fact, please note that the AUX output is configured for defrost control only with OAU=DEF.

DTY	DEFROST	COMPRESSOR
OFF	Off	Off
ELE	On	Off
GAS	On	On

Table 3

5.3 Defrost lasts for the time **DTO** but, if the evaporator probe has been enabled (T2=YES) and temperature **DLI** is achieved before this time elapses, defrost will be terminated in advance.

If parameter **DRN** is greater than 0, before cooling starts all outputs will remain off for the time assigned to DRN. This phase, called drain down, will allow a complete ice melting and the drain of the resulting water.

* The actual defrost frequency depends on the selection I/II: in mode **I**, the reference parameter is **DFR** while in mode **II** it's **IIDF**.

6. EVAPORATOR FANS

6.1 During thermostatic control, the evaporator fans are controlled by parameters ***FTC**, **FT1**, **FT2** and **FT3**.

With **FTC=YES** an optimised fan control is enabled; in other words the fans will work in conjunction with the compressor (heater), and after the compressor has stopped, the fans remain On for the time **FT1** (energy recovery), after that they will remain Off for the time **FT2** (energy saving). After FT2, the fans will be On for the time **FT3** (whirling air stratifications).

Example: FT1=30, FT2=4, FT3=1. With those values the fans will cut-in together with the compressor and will stop 30 seconds after the compressor has stopped; now, a 4 minute OFF and 1 minute ON cycle will take place till the compressor starts again.

With FT2=0 the fans will be On all the time; with FT2 greater than 0 and FT3=0 they will always be Off.

With FTC=NO optimised fan control is excluded, therefore the fans will always be active.

6.2 If the AT2-5 is connected to a door switch and door switch control is enabled (DS=YES), during thermostatic control if the door is opened, the fans will be stopped immediately.

6.3 During defrost, the fans are controlled by parameter **FID**; with FID=YES the fans remain On all through defrosting. With FID=NO, the fans will be stopped and will only re-start after defrost, when the conditions in paragraph 6.4 have been met.

6.4 After defrosting, if probe T2 is active (T2=YES), temperature **FDD** provides evaporator fan re-start. So the evaporator fans will remain off until the evaporator has a temperature higher than FDD. If such condition doesn't occur within 4 minutes following defrost termination, the fans will however be switched on again.

* The way the fans will be controlled depends on the selection **I/II**: in mode I they work according to **FTC**, while in mode II the fans work according to **IIFT**.

7. ALARMS



With AT2, correct operation of the thermostat may be monitored by a wide range of functional and diagnostics alarms, individually selectable by means of the relevant parameters. The alarm warnings are given on the display through explicit indications (see following par.), with the AUX contacts switching (if the AUX relay is enabled with OAU=AL0 or AL1), and intermittent buzzer sounding. During an alarm, by pressing any button, the buzzer is muted. Then, if the alarm persists, the buzzer will be periodically switched on for 20 seconds every 60 minutes, until the alarm ends (the display indications remain on all the time). The repeated acoustic warning applies to all alarms with the exception of the condenser cleaning alarm. Operation of the various elements is given in detail below.

7.1 The parameters **ALx** and **AHx** are the alarm thresholds to determine a correct operation of the application. According to the value given to **ATM**, the thresholds may be ABSOLUTE or RELATIVE. With ATM=ABS, the values programmed for **ALA** and **AHA** will represent the real alarm temperatures. With ATM=REL, **ALR** and **AHR** determine the alarm differentials referred to setpoint and setpoint + hysteresis. In this case, setting one or both differentials to zero cuts out the corresponding alarm. With ATM=NON, all temperature alarms are inhibited.

Example 1: ATM=ABS, ALA=2.5, AHA=18.0; the thresholds are set at +2.5° and +18°.

Example 2: ATM=REL, C-H=REF, SP=-20, HYS=2.0, ATL=-5.0, ATH=05.0; the thresholds are set at -25° (-20-5) and -13° (-20+2+5).

Example 3: ATM=REL, C-H=HEA, SP=75, HYS=3, ATL=-10, ATH=7; the alarm thresholds are set at +62° (75-3-10) and +82° (75+7).

The alarm warning may be immediate or delayed by the time **ATD** whenever this is greater than 0. The indication  for high temperature alarm and  for low temperature alarm blinks on the display. The alarm indication remains stored in the display, even when the alarm is over, until you acknowledge the alarm manually by pressing any button.

Temperature alarms are inhibited during defrosting.

7.2 If a suitable door switch has been connected to detect the door status and door switch input control has been enabled (DS=YES), the door open alarm function is enabled. In this way, if the door remains open the controller will react after the time delay set with **ADO** by displaying the alarm source through the indication .

7.3 Assigning a value greater than 0 to the parameter **ACC** enables the indication for periodic cleaning of the condenser. Subsequently, when the count of compressor hours of operation reaches the equivalent in weeks set with ACC, an indication for cleaning appears on the display.

*Example: with ACC=16 there is a warning once every $16 \times 7 (\text{weeks}) \times 24 (\text{hours}) = 2688$ hours of **compressor operation**, so, assuming for this an operation with 5 minutes On and 5 minutes Off - after approx. 32 weeks.*

In order to clear the time counter, follow the prescribed procedure in paragraph 2.3.

7.4 Upon failure of probe T1 or, if enabled, probe T2, probe failure is signalled with the blinking indication  or  respectively.

8. TEMPERATURE STORAGE

The AT2 features a system for permanent storage of the minimum and maximum temperature logged during operation. This system is a valid help to achieve compliance with the HACCP directive in its part relating to a correct preservation of foodstuffs. Temperature is measured by probe T1 which should therefore be placed in a point where the temperature of the preserved product may always be measured correctly. The logging is however subject to some simple rules that filter the data and give a rational interpretation. The logging is suspended during the periods in which the refrigerator is put on a standby and during defrostings and, during the normal operation (thermostatic control), it's "slowed down" through the parameter **TLD**. This parameter defines the time during which the measured temperature must permanently exceed the current value before the logging is performed. In this way, it will be possible to avoid idle loggings that don't reflect the actual product temperature, for example, the door remaining open for a short period of time, the temperature recovery after a defrost or other temporary short term temperature huntings.

It is suggested that a reasonably long TLD time is programmed, for instance 5-15 minutes, you then put the product into the refrigerator and start a new logging cycle by clearing previous values (see par. 2.3). It will now suffice that at regular intervals, in the INFO menu you check the minimum and maximum logged values in order to know if the product has been kept within the required temperature limits.

9. AUXILIARY FUNCTIONS

9.1 In addition to the basic functions described above, the AT2 offers an innovative feature to enhance the performance of the refrigerator. In fact, you can select the control parameters between two different pre-programmed groups, in order for the fundamental control parameters to be adapted quickly to changing needs such as, for example: High/Low Temperature range change, day/night operation, stored product change (meat, fish, vegetables ...), maximum cooling capacity or energy saving. The parameters switched over in mode **I** and **II** are: **SPL, SPH, SP, HYS, FTC, DFR** and **IISL, IISH, IISP, IIHY, IIFT** and **IIDF**.

With the parameter **IISM** you select if the changeover from Group **I** to Group **II** is made manually, via the button  pressed for 2 seconds (IISM=MAN), or inhibited (IISM=NON). The activation of Group **II** is signalled by the lighting up of the relevant LED on the controller display.

9.2 You select the sensor type for the measurement of temperatures T1 and T2 through the parameter **INP**. With INP=SN4, probes T1 and T2 must be the LAE models NTC SN4.. and with INP=ST1 the probes must be the LAE models PTC ST1.. With INP=ST1 you can only choose the scales with 1° resolution (SCL=2°C or SCL=°F).

9.3 The operation of auxiliary output is determined by the parameter **OAU**. With OAU=0-1, the relay contacts follow the on/off status of controller (standby=OFF); with OAU=DEF the output is programmed for defrost control (see 5.2). With OAU=LGT the output is enabled to control the lights manually, through the button  (**LSM=MAN**), or lights are switched on when the door is opened (**LSM=DOR**). Finally, with OAU=AL0, the AUX contacts open when an alarm condition occurs; alternatively, with OAU=AL1, the AUX contacts close when an alarm occurs.

With OAU=NON, the AUX output is disabled and the contacts remain constantly opened.

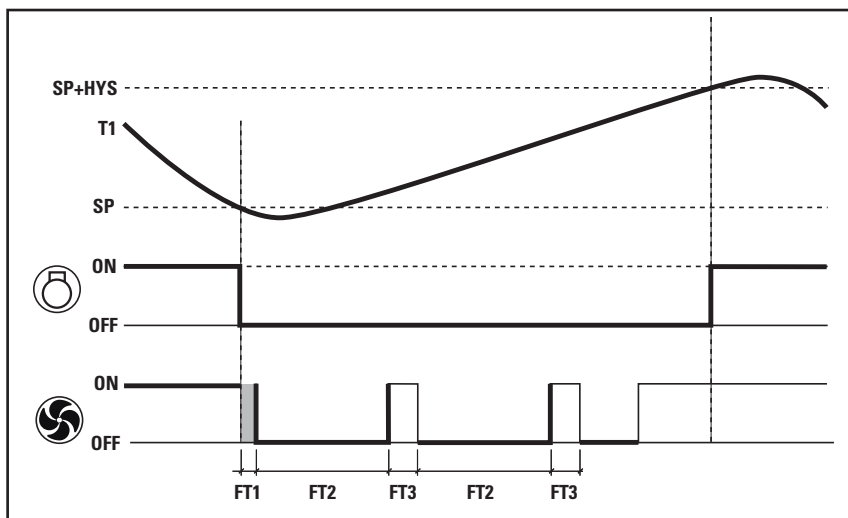
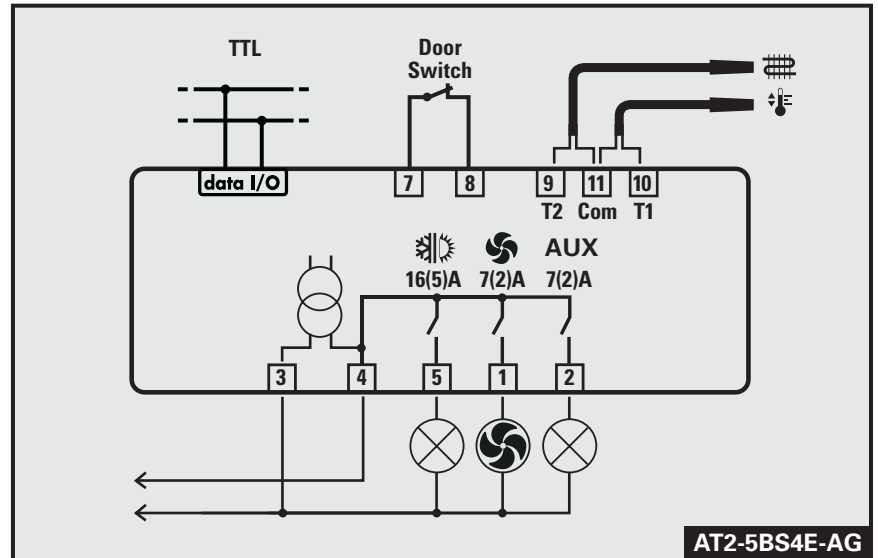

Figure 1 Thermostat and Fan Operation

WARRANTY

LAE electronic SPA guarantees its products against defects due to faulty materials or workmanship for one (1) year from the date of manufacture shown on the container. The Company shall only replace products which are shown to be defective to the satisfaction of its own technical services. The Company shall not be under any liability and gives no warranty in the event of defects due to exceptional conditions of use, misuse or tampering. LAE electronic does not accept units back unless LAE electronic has previously given its allowance or request.

WIRING DIAGRAM



AT2-5BS4E-AG