

CDC122T1R2 CDC122T1R3B CDC122T1R3G CDC122T1R3J

We thank you for choosing an LAE controller. Before proceeding to the installation of the CDC 12, please read this instructions sheet carefully; only in this way you will obtain maximum performances and safety.

1. INSTALLATION

1.1 The CDC122T1R2 and CDC122T1R3B have got a size of 77x35x77 mm (WxHxD), while the CDC122T1R3G and CDC122T1R3J have got a size of 77x35x97 mm (WxHxD). The instrument is inserted into the panel through a 71x29 mm hole and secured via the suitable brackets exerting correct strength. The rubber gasket must be placed between the panel and the instrument front, so please make sure that there are no gaps allowing liquid infiltrations.

1.2 The unit works with an ambient temperature between -10°...+50°C and 15%...80% relative Humidity. To reduce the effects of electro-magnetic interference, place the cables carrying signals (probes and serial connections etc.) and the controller as far away as possible from power lines.

1.3 Probes, power supply, inputs and outputs must be wired strictly following the diagram indicated on the enclosure, where the maximum loads also appear. For supply voltage, the suitable transformer (mod. TRxxx) must be used.

1.4 Probe T1 measures air temperature and is used for the thermostat function; probe T2 measures the evaporator temperature and must be secured to it on the place where the maximum frost growth occurs.

1.5 The remote defrost start input needs an external activation voltage between 10 ... 16Vac, 10mA. When this voltage is applied to the input, defrost is started.

1.6 The RS485 serial communication port or, if fitted, the TTL output for the remote display is available on the DATA connector. PIN 1 is identified by a dot.

Caution:

- If the relays switch a large load frequently, we suggest you contact us to obtain information about the relay contact life.
- Where delicate or valuable products have to be maintained under strict conditions, please use a different controller for limit and alarm functions.

2. CONTROL PARAMETERS



The adaptation of the CDC 12 to the system that it controls is achieved through the parameters in the SETUP. Access to the parameters is obtained by pressing $\square + \square + \square$ for 4 seconds. Scroll through the parameters by pressing \square or \square until you select the desired one. Check its value by means of \square and change it via $\square + \square$ or \square . Exit from the SETUP occurs after 10 seconds of no key activation. To help yourself during programming, refer to the following table.

SPL	minimum programmable temperature	[-50 ... +150°]
SPh	maximum programmable temperature	[SPL ... +150°]
hyS	thermostat on switching hysteresis	[+01 ... +20°K]
coF	cooler minimum off time	[00 ... 10 minutes]
con	cooler minimum on time	[00 ... 10 minutes]
cdc	cooler safety run in case of probe failure	[00=off ... 10(0)%=always on]
crS	cooler re-start delay after power failure	[00 ... 120 seconds]
drE	hours between two defrosts	[01 ... 99 hours]
dLi	defrost limit temperature	[+01 ... +70°]
dto	defrost time-out	[01 ... 120 minutes]
drP	drain time	[00 ... 10 minutes]
diS	display control during defrost	[-01="dEF"; 00="T3"; 1... 30 minutes=timed "dEF"]
dty	defrost type	[FAn=off cycle; ELE=electrical; GAS=hot gas]
doP	time count for defrost optimisation	[con=continuous; Acc=frost accumulation]
Fct	evaporator fan control	[-01=always on; 00=on/off with cooler; 1... 10 minutes=delayed off]
FrS	fan re-start after defrost	[-50 ... +150°]
Fid	ventilation during defrost	[00=off; 01=T2<FrS; 02=always on]
AlO	low alarm threshold	[-50 ... +150°]
AhI	high alarm threshold	[AlO ... +150°]
AdL	temperature alarm delay	[-01=excluded; 00... 120 minutes]
Ain	alarm temperature selection	[temperature 1, 2, 3]
oS1	thermostat probe offset	[-20 ... +20°K]
oS2	evaporator probe offset	[-20 ... +20°K]
oS3	displayed probe offset	[-20 ... +20°K]
SiM	slowdown of displayed temperature	[00 ... 200]
Adr	peripheral number	[00 ... 255]

3. DISPLAYS

3.1 DURING ORDINARY CONTROL. At the power up, the display shows "-" for 5 seconds during which the unit carries out a self-check; then the temperature T3 appears. In some cases, owing to the structure of the cabinet or air stratification, the probes can not measure the desired temperature. If necessary, through the parameters **oS1**, **oS2** and **oS3** the temperatures **t1**, and **t2** measured by the probes can be adjusted in order to obtain the desired values for computing: thermostat **T1=t1+oS1**; defrost **T2=t2+oS2**; display **T3=t1+oS3**.

Ex.: Setpoint= -20°; **oS1**= -2°K; **oS3**= +6°K, temperature **t1** is controlled at -18° and the display shows -12°.





Through the **SiM** parameter it's possible to reduce the fluctuations of the displayed temperature by simulating the behaviour of product core temperature. The slowdown is proportionated to the value programmed to **SiM** (ex.: 100 simulates approx. a 0.5 l bottle of water). To display the instantaneous temperatures T1, T2 or T3 press ,  or  respectively.

3.2 DURING DEFROST. The display is controlled according to the parameter **diS**, if **00** temperature T3 continues to be displayed. If **diS= -01**, then the display shows "dEF" since defrost start as long as the temperature T1 is higher than setpoint+hysteresis **hYS**. By programming a value between **1** and **30** minutes, after the defrost "dEF" is still displayed until the time programmed has elapsed unless the above condition is reached before.

3.3 OTHER DISPLAY STATUS. During an alarm condition, "ALM" blinks on display. The stand-by status, in which all outputs are off, is signalled with permanent "-". If the keypad has been locked through the serial communication, when attempting to perform any changes, the display shows "inh". The optional remote display (CDCREMOTO) repeats the indications of the CDC12 to which it's connected, except during the alarms which are indicated with "-". When a fault in communication occurs, the remote unit shows "...-" (only the line in the centre).



4. THERMOSTAT FUNCTION

At power-up the cooler start is delayed by the sum of **coF** and **crS**; this latter is used in those applications where it is necessary, after a line dropout, to avoid simultaneous starts of many compressors at the power-up. For ex.: **coF**= 03, **crS**= 05; after power-up, at least 03 minutes and 05 seconds must elapse before the cooler starts. **coF** and **con** are, respectively, the cooler minimum off and on time. The relay which controls the cooler, after switching off/on or on/off, will remain in that status for at least the pre-programmed time. When you have to maintain a very small hysteresis **hYS**, we recommend to program a suitable value for **coF** and **con** to ensure a long life to relay/contact and compressor.

Temperature control is based on the comparison between temperature T1, the setpoint and the hysteresis **hYS** programmed. The setpoint is displayed by pressing . To change it, keep  pressed and by pushing key  or , select the desired value within the limits **SPL** and **SPh**. The cooler on switching temperature is achieved by adding **hYS** to the setpoint.

Ex.: setpoint=03; **hYS**=04, the relay is off with T1=-03°C and on with T1=+01°C.

When a failure or overrange of probe T1 occurs, the cooler run isn't controlled according to setpoint but determined by **cdc** which represents the cooler duty cycle, i.e. (on time)/(10 minute cycle). For ex.: 04= 4 minutes on time, 6 minutes off time. The **cdc** value has to be set taking into consideration the normal cooler duty cycle.

If you wish to switch off the outputs, you can put the CDC12 on a standby via the serial communication or manually, by pressing ++ during self-check following the power-up. During the standby temperature control and serial communication however remain active. If the CDC12 is on a standby, you can get it to go out of this status and resume its ordinary operation by following the same procedure as described above.



5. DEFROST START

5.1 TIME COUNT. If **doP=con**, then the time count is continuous, therefore defrosts take place at regular intervals in hours set with parameter **drE**. If **doP=Acc**, then the built-in timer only counts when a frost growth condition occurs (i.e. fin temperature lower than 0° and below the dew point) until reaching the **drE** time. If the evaporator works at around 0°, defrost frequency depends on the thermal load and the climatic condition (external air temperature and humidity). If setpoint is much lower than 0°, then defrost frequency mainly depends on the cooler on times. Ex. If the cooler cycle is 5 minutes on and 5 minutes off and **drE**= 04 hours, defrost takes place every 8 hours approximately.

After a power failure, the defrost timer resumes the time count from where it was interrupted with ±30 minute approximation.

5.2 REMOTE START. It allows to start a defrost remotely regardless of the time elapsed. This function permits to perform defrosts not homogeneously spread in time or according to a program. The activation of the remote start **anticipates a defrost**, of which start is however determined by **drE**.

Ex. If **drE**=12 and within 12 hours since the last defrost no start signal is sent to the CDC12, then defrost will however take place. This function overlap avoids that a fault in the remote control or in the connection excludes any defrost.

5.3 MANUAL DEFROST. It is possible to manually start or abort defrost by pushing +.

6. DEFROST FUNCTION

6.1 EVAPORATOR HEATING. During defrost the status of the outputs is determined by parameter **dtY**. If **dtY=FA**n, then the evaporator fans are kept on, while cooler and defrost outputs are off. If **dtY=ELE**, during defrost the cooler is switched off and the defrost output on. If **dtY=GAS**, cooler and defrost outputs are on all through defrost.

6.2 TERMINATION. When defrost is on, it can be terminated in different ways: if defrost time-out **dto** is greater than **0**, it gives the maximum defrost duration in the event that temperature T2 doesn't match the **dLi** value before. If **dto=0**, then defrost ends when either temperature **dLi** is achieved or when the remote contact is opened.

Warning: if you don't use the remote defrost start input and you program **dto=0**, then defrost will be aborted immediately after its start!

6.3 DRIPPING. After the heating phase, the dripping time **drP**, by delaying the cooler re-start, allows a homogeneous heat spread all over the evaporator and the drain of the drops of water.

The defrost LED is lit when the corresponding output is On; it blinks during defrost through "air blowing" and dripping time.

When probe T2 is faulty, any new defrost is inhibited.

7. EVAPORATOR FAN CONTROL

7.1 RUN WITH THERMOSTAT. During temperature control, the fans can work in three different ways. If **Fct=-01**, the fans work continuously. If **Fct=00**, the fans are stopped simultaneously with the cooler. If **Fct** is set between **1** and **10** minutes, after the cooler has stopped, the fans continue to run for the programmed amount of minutes. In both latter two cases, the fans are switched on simultaneously with the cooler.

7.2 RUN DURING AND AFTER DEFROST. During and immediately after defrost, the fans are controlled by parameters **Fid** and **FrS**. If **Fid=00**, at the start and all through defrost the fans are off; they are switched on again, after compressor re-start, when the evaporator probe T2 matches the **FrS** temperature. If **Fid=01**; in this case the fans are active as long as the evaporator has a temperature lower than **FrS**. If **Fid=02**; all through defrost the fans are on (even with **dty=ELE** or **GAS**).

8. ALARM FUNCTION AND PROBE FAILURE

A check on the correct refrigeration plant function is performed by monitoring temperature T1, T2 or T3, selectable via **Ain** parameter. **ALo** and **Ahi** determine, respectively, the lower and higher temperature alarm threshold.

AdL allows the control of the alarm function: with **-01** the temperature alarm is excluded, while, if this parameter is **00**, the alarm output is on immediately when the condition is detected. If **AdL** is programmed between **01** and **120** minutes, the temperature must constantly remain over the alarm threshold for the chosen time before the signalings take place.

When the alarm starts, "ALM" blinks on the display, alarm relay and buzzer are switched on. The signalings remain, **even when the alarm condition is over**, until the alarm is "acknowledged" by pressing any key. Now, if the temperature is within the alarm limits, any alarm indication disappears. Otherwise the current temperature is displayed alternating with "ALM", the relay is always on and, for 1 min. every 30, the buzzer beeps; all this happens as long as the alarm condition persists.

As a result of failure or overrange of one of the probes, the display shows either "PF1" or "PF2", the alarm output is switched on immediately. Also in this case the condition must be acknowledged by pressing any key.

The alarm output contact is also closed when the instrument is powerless.

During defrost and dripping, the high alarm monitoring is inhibited.

9. PROBE RE-CALIBRATION

Should it be necessary to recalibrate the unit, for instance in consequence of probe replacement, then act in the following way: get an accurate reference thermometer or calibrator; make sure that the **offset oSx** of the **probe** to be **re-calibrated is 00**; switch off then on the unit. During the self check (5 seconds from power-up), press **⏏+⏏+⏏**. When the re-calibration function is active choose the desired section by means of **⏏** or **⏏**: **0A1** and **0A2** allow 0°C calibration of the respective probe. **SA1** and **SA2** allow high temperature calibration to rectify a gain error. After selecting the desired parameter, press **⏏+⏏** or **⏏** to match the read-out value with the one of the reference instrument (make sure the temperature is stable).

Exit from the recalibration occurs after 10 seconds of no key activation. Therefore, to avoid exit, keep **⏏** pressed for as long as you need.

10. SERIAL COMMUNICATION

If fitted, the RS485 serial port allows the CDC12 to take part as a peripheral in a data communication network managed by a master PC supervisor. The data base puts all measurement and control data on line as well as the output status. **Adr** is the unit identification number within the network.

Through the serial communication it's possible to change all control parameters (setpoint and SETUP), start defrost cycles, put the controller on a standby or inhibit the controller keypad in order to avoid unauthorised access to programming function.

WARRANTY

LAE electronic Srl warrant that their products are free of any defects in workmanship and materials for a period of 1 (one) year from date of production shown on the enclosure. LAE electronic Srl shall only repair or replace those products of which defects are due to LAE electronic Srl and recognised by their technicians. LAE electronic Srl are not liable for damages resulting from malfunctions of the products.

Defects due to exceptional operating conditions, misapplication and/or tampering will void the warranty.

All transport charges for returning the product to the manufacturer, after prior authorisation by LAE electronic Srl, and for the return to the purchaser are always for the account of the purchaser.

SETUP				
1	SPL	-50 ... 150	-30	
2	SPh	SPL ... 150	20	
3	hyS	01 ... 20	02	
4	coF	00 ... 10	00	
5	con	00 ... 10	00	
6	cdc	00 ... 10	05	
7	crS	00 ... 120	00	
8	drE	01 ... 99	06	
9	dLi	01 ... 70	10	
10	dto	01 ... 120	30	
11	drP	00 ... 10	03	
12	diS	-01 ... 30	10	
13	dty	FAn; ELE; GAS	ELE	
14	doP	con; Acc	con	
15	Fct	-01; 00... 10	01	
16	FrS	-50 ... 150	-10	
17	Fid	00; 01; 02	00	
18	Alo	-50 ... 150	-32	
19	Ahi	Alo ... 150	22	
20	AdL	-01; 00... 120	10	
21	Ain	1; 2; 3	01	
22	oS1	-20 ... 20	00	
23	oS2	-20 ... 20	00	
24	oS3	-20 ... 20	00	
25	SiM	00 ... 200	00	
26	Adr	00 ... 255	01	

WIRING DIAGRAM

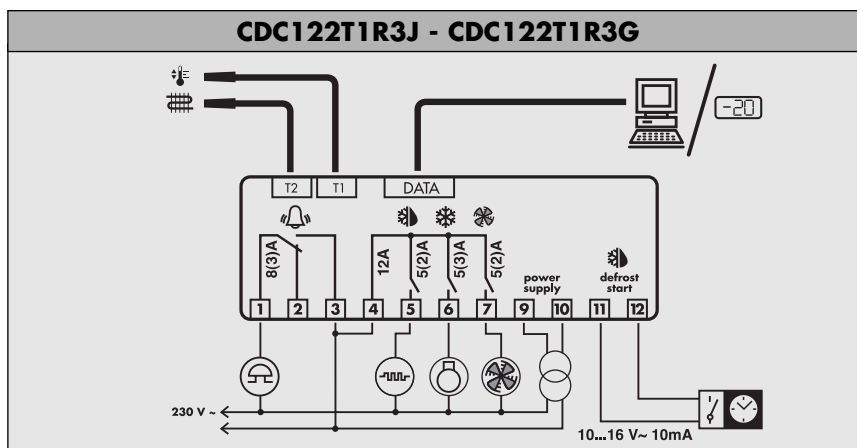
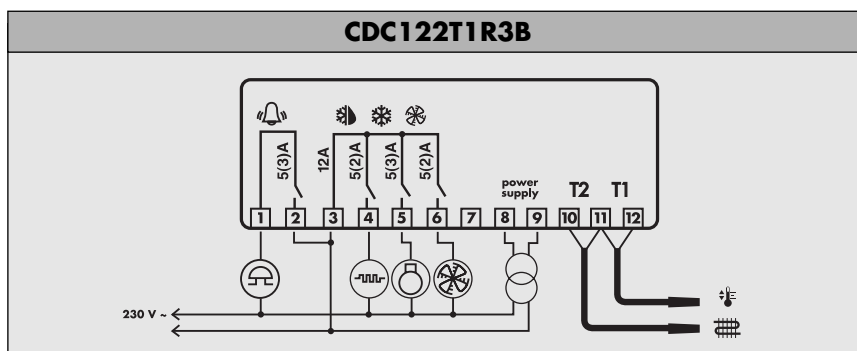

PARTNER VENEZIA • 041 5460713



VIA PADOVA, 25
 31046 ODERZO /TV /ITALY
 TEL. 0422 815320 - 815303
 TELEFAX 0422 814073
 www.lae-electronic.com
 E-mail: info@lae-electronic.com