

LTR-5 INSTRUCTIONS FOR USE

Thank you for having chosen a LAE electronic product. Before installing the instrument, please read these instructions carefully to ensure maximum performance and safety.



DESCRIPTION





Fig.1 — Front panel

INDICATIONS

OUT1 Thermostat output

-  Setpoint button.
-  Decrease button.

-  Increase button.
-  Exit / Stand-by button.

INSTALLATION

- Insert the controller through a hole measuring 71x29 mm.
- Make sure that electrical connections comply with the paragraph “wiring diagrams”. To reduce the effects of electromagnetic disturbance, keep the sensor and signal cables well separate from the power wires.
- Fix the controller to the panel by means of the suitable clips, by pressing gently; if fitted, check that the rubber gasket adheres to the panel perfectly, in order to prevent debris and moisture infiltration to the back of the instrument.
- Place the probe T1 inside the room in a point that truly represents the temperature of the stored product.





OPERATION

DISPLAY

During normal operation, the display shows either the temperature measured or one of the following indications:

OFF	Controller in stand-by	E1	In tuning: timeout1 error
OR	Probe T1 overrange or failure	E2	In tuning: timeout2 error
TUN / 5.4	Controller in autotuning	E3	In tuning: overrange error









SETPOINT (display and modification of desired temperature value)

- press button  for at least half second, to display the setpoint value.
- By keeping button  pressed, use button  or  to set the desired value (adjustment is within the minimum **SPL** and the maximum **SPH** limit).
- When button  is released, the new value is stored.

STAND-BY

Button , when pressed for 3 seconds, allows the controller to be put on a standby or output control to be resumed (with **SB=YES** only).

RECALIBRATION









- Have a precision reference thermometer or a calibrator to hand.
- Ensure that **OS1=0** and **SIM=0**.
- Switch the controller off then on again.
- During the auto-test phase, press buttons  + , and keep them pressed till the controller shows **0AD**.
- With buttons  and  select **0AD** or **SAD**: **0AD** allows a calibration of 0, inserting a constant correction over the whole scale of measurement. **SAD** allows a calibration of the top part of the measurement scale with a proportional correction between the calibration point and 0.
- Press  to display the value and then use  +  or  to make the read value coincide with the value measured by the reference instrument.
- Exit from calibration by pressing button .

CONTROLLER AUTOTUNING IN PID MODE



Before starting

- Adjust the setpoint **1SP** to the desired value.
- Set **1Y=PID**.
- Make sure that the **1PB** value matches the desired control mode (**1PB**<0 for heating; **1PB**>0 for refrigeration).

Start autotuning

- Keep buttons  +  pressed for 3 seconds. **1CT** blinks on the display.
- With  +  or  set the cycle time in order to define the dynamic of the process to be controlled.
- To start autotuning press  +  or wait for 30 seconds. To abort the autotuning function, press .

During autotuning

- During the entire autotuning phase, the display alternates  with the actual temperature measured.
- In case of power failure, when power is resumed, after the initial autotest phase, the controller resumes the autotuning function.
- To abort the autotuning, without modifying the previous control parameters, keep button  pressed for 3 seconds.
- After the autotuning has taken place successfully, the controller updates the control parameters and start to control.

Errors

- If the autotuning function failed, the display shows an error code:
- E1 timeout1 error: the controller could not bring the temperature within the proportional band. Increase **1SP** in case of heating control, vice versa, decrease **1SP** in case of refrigerating control and re-start the process.
- E2 timeout2 error: the autotuning has not ended within the maximum time allowed (1000 cycle times). Re-start the autotuning process and set a longer cycle time **1CT**.
- E3 temperature overrange: check that the error was not caused by a probe malfunction, then decrease **1SP** in case of heating control, vice versa increase **1SP** in case of refrigerating control and then re-start the process.
- To eliminate the error indication and return to the normal mode, press button .

Control improvement

- To reduce overshoot, reduce the integral action reset **1AR**.
- To increase the response speed of the system, reduce the proportional band **1PB**. Caution: doing this makes the system less stable.
- To reduce swings in steady-state temperature, increase the integral action time **1IT**; system stability is thus increased, although its response speed is decreased.
- To increase the speed of response to the variations in temperature, increase the derivative action time **1DT**. Caution: a high value makes the system sensitive to small variations and it may be a source of instability.

WIRING DIAGRAMS

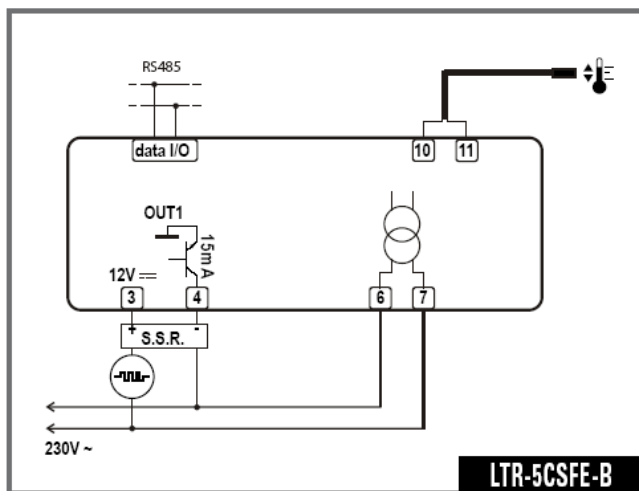
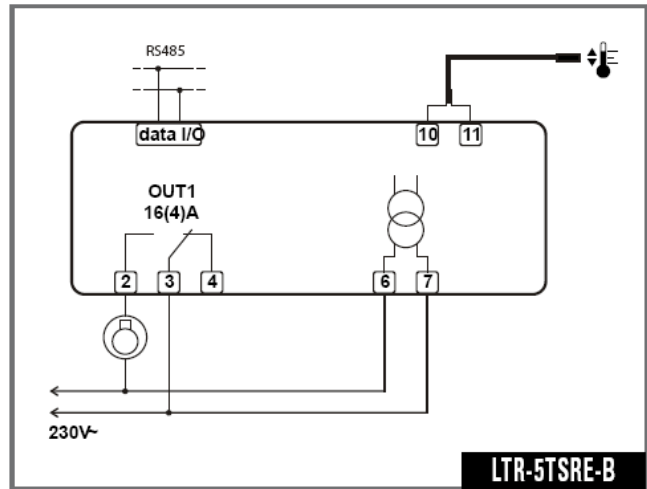
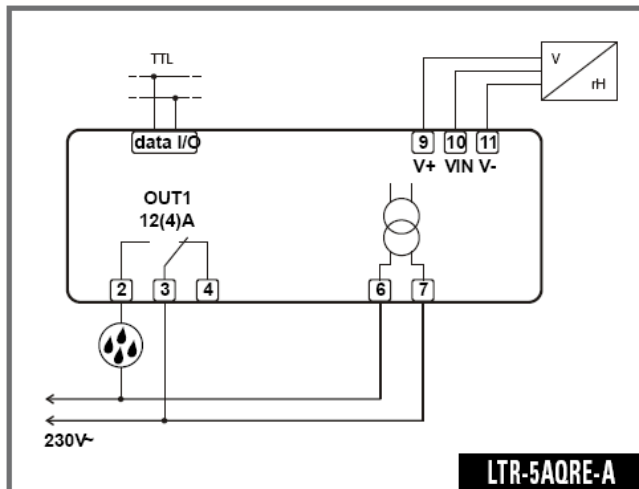

TECHNICAL DATA

Power supply

LTR-5...D	12Vac±10%, 50/60Hz, 2W
LTR-5...E	230Vac±10%, 50/60Hz, 2W
LTR-5...U	115Vac±10%, 50/60Hz, 2W

Relay outputs (LTR-5..R..)

LTR-5.SR..	OUT1 16(4)A
LTR-5.QR..	OUT1 12(4)A

SSR drive (LTR-5..F..)

OUT1	15mA 12Vdc
------	------------

Inputs

LTR-5A...:	0-1V
LTR-5C...:	NTC 10KΩ@25°C, part No. LAE SN4...
LTR-5T...:	PTC 1000Ω@25°C, part No. LAE ST1...

Measuring Range

LTR-5A...:	0...99%r.H.
LTR-5C...:	-40...125°C
LTR-5T...:	-50...150°C

Measuring accuracy

LTR-5A...:	<±0.7%r.H. in the measuring range
LTR-5C...:	<±0.3°C -40...100°C; ±1°C out of that range
LTR-5T...:	<±0.3°C -50...140°C; ±1°C out of that range

Operating conditions

-10 ... +50°C;	15...80% r.H.
----------------	---------------

CE (Reference Norms)

EN60730-1; EN60730-2-9;
EN55022 (Class B);
EN50082-1

Front protection

IP55

CONFIGURATION PARAMETERS

- Setup menu is accessed by pressing buttons \leftarrow + \rightarrow for 5 seconds.
- With button \downarrow or \uparrow select the parameter to be modified.
- Press button \leftarrow to display the value.
- By keeping button \leftarrow pressed, use button \downarrow or \uparrow to set the desired value.
- When button \leftarrow is released, the newly programmed value is stored and the following parameter is displayed.
- To exit from the setup, press button \rightarrow or wait for 30 seconds.

PAR	RANGE	DESCRIPTION
SCL	1°C; 2°C; °F	<p>Readout scale.</p> <p>1°C : measuring range -50/-19.9 ... 99.9/150°C for LTR-5T -40/-19.9 ... 99.9/125°C for LTR-5C 0.0 ... 99.9 %r.H. for LTR-5A</p> <p>2°C : measuring range -50 ... 150°C for LTR-5T -40 ... 125°C for LTR-5C 00 ... 99 %r.H. for LTR-5A</p> <p>°F : measuring range -60 ... 300°F for LTR-5T -40 ... 250°F for LTR-5C</p> <p>Caution: upon changing the SCL value, it is then <u>absolutely</u> necessary to re-configure the parameters relevant to the absolute and relative temperatures (SPL, SPH, 1SP, 1HY, etc..).</p>
SPL	-50..SPH	Minimum limit for 1SP setting
SPH	SPL.150°	Maximum limit for 1SP setting
1SP	SPL... SPH	Setpoint (value to be maintained in the room).
1Y	HY / PID	<p>Control mode.</p> <p>With 1Y=HY you select control with hysteresis: parameters 1HY and 1CT are used.</p> <p>With 1Y=PID you select a Proportional-Integral-Derivative control mode: parameters 1PB, 1IT, 1DT, 1AR, 1CT will be used.</p>
1HY	-19.9...19.9°C	<p>Thermostat differential [control with hysteresis].</p> <p>Set 1HY on a value greater than zero to make the output work in refrigerating mode, vice versa set on a value lower than zero to make the output work in heating mode. With 1HY=0 the output is always off.</p> <div style="display: flex; justify-content: space-around;"> <div style="text-align: center;"> <p>Fig. 1a. ON/OFF refrigerating control (1Y=HY, 1HY>0)</p> </div> <div style="text-align: center;"> <p>Fig. 1b. ON/OFF heating control (1Y=HY, 1HY<0)</p> </div> </div>
1PB	-19.9...19.9°C	<p>Proportional band [PID control].</p> <p>Set 1PB on a value greater than zero to make the output work in refrigerating mode, vice versa set on a value lower than zero to make the output work in heating mode. With 1PB=0 the output is always off.</p> <p>With a proportional controller, the temperature is controlled by varying the time of activation of the output. The nearer the temperature to set point, the less time of activation. A small proportional band increases the promptness of response of the system to temperature variations, but tends to make it less stable. A purely proportional control stabilises the temperature within the proportional band but does not cancel the deviation from the set point.</p> <div style="text-align: center;"> </div>

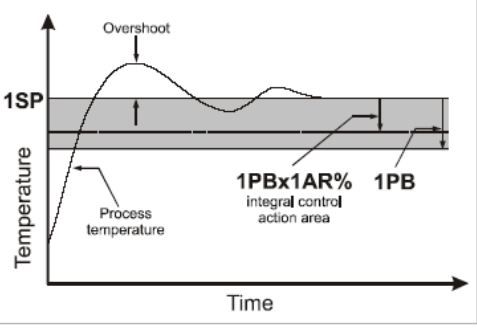
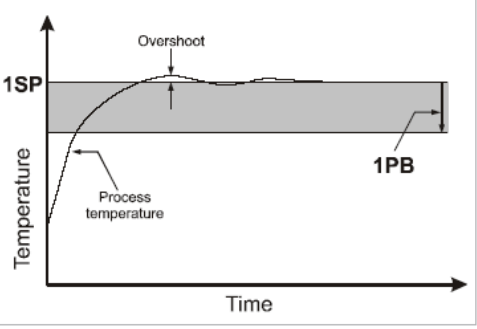
1IT	0...999s	<p>Integral action time [PID control].</p> <p>The steady-state error is cancelled by inserting an integral action into the control system. The integral action time, determines the speed with which the steady-state temperature is achieved, but a high speed (1IT low) may be the cause of overshoot and instability in the response. With 1IT=0 the integral control is disabled.</p>	
1DT	0...999s	<p>Derivative action time [PID control].</p> <p>Response overshoot in a system controlled by a Proportional-Derivative controller may be reduced by inserting a derivative action in the control. A high derivative action (1DT high) makes the system very sensitive to small temperature variations and causes instability. With 1DT=0 the derivative control is disabled.</p>	
1AR	0...100%	<p>Reset of integral action time referred to 1PB [PID control].</p> <p>Decreasing the parameter 1AR reduces the integral control action zone, and consequently the overshoot (see figure on paragraph 1IT).</p>	
1CT	0...255s	<p>Cycle time.</p> <p>In the ON/OFF control (1Y=HY), after the output has switched on or off, it will remain in the new state for a minimum time of 1CT seconds, regardless of the temperature value.</p> <p>In the PID control (1Y=PID), the cycle time is the period of time in which the output completes a cycle (Time ON + Time OFF). The faster the system to be controlled reacts to temperature changes, the smaller the cycle time should be, in order to obtain a greater temperature stability and less sensitivity to load variations.</p>	
1PF	ON / OFF	Output state in case of probe failure.	
BAU	NON / SBY	With BAU=SBY , the stand-by button is enabled.	
SIM	0...100	Display slowdown.	
OS1	-12.5..12.5°C	Probe T1 offset.	
ADR	1...255	LTR-5 address for PC communication.	