

**SSD90Axx (x-C)
SMD12RU
SMD34RU**

We thank you for choosing an LAE controller. Before proceeding to the installation, please read this instructions sheet carefully; only in this way you will obtain maximum performance and safety.

1. INSTALLATION

- 1.1** The SSD90 must be secured to the panel by means of screws or rivets to be inserted into the appropriate slots. Protection is IP30, therefore please locate the unit in a position ensuring that no liquid infiltrates and damages the board.
- 1.2** Probe, power supply and outputs must be connected strictly according to the indications appearing on the board; the cables can pass through the hole on the unit side. For supply voltage and maximum switchable loads, please read the label on the enclosure. The flat cable of the remote unit must be connected making sure that the mechanical polarity is respected, finally secure the flat cable firmly by means of the suitable cable tie.
- 1.3** The SMD12RU remote unit is secured to the panel by means of the two springs at its box sides. The unit is mounted on the panel through a 29x71 mm opening, exert a moderate pressure so as to get the SMD12RU to adhere to the panel perfectly. Differently, as to the SMD34RU model, remove the two side screws and open the enclosure. Mount the front of the remote unit through a 31x185 mm opening on the panel and then match it to the rear cover. Then finally close the box by means of the screws.
- 1.4** Probe T1 measures the air temperature and is used for the thermostat function. It must be located inside the room in a place that well reflects the temperature of the preserved product.
- 1.5** The unit works with an ambient temperature between -10°..+50°C and 15%..80% of relative humidity. To reduce the effects of electro-magnetic interference, place the probe and signal cables as away as possible from power lines.









CAUTION: •If the relays switch a large load frequently, we suggest you contact us to obtain information about the relay contact life.
•Where delicate or valuable products have to be maintained under strict conditions, we suggest you use a second unit for limit and alarm purpose.

2. OPERATING LEVELS

For three seconds from the power-up the display illuminates a dash (self-check phase). The following indications depend on the operating status of the controller and from the menu level activated by the operator.
On TABLE 1 you can find status, levels and relevant indications.

STANDBY	NORMAL	INFO MENU	INFO DATA	SETUP MENU	PARAMETER VALUE
OFF Not in operation	-20 Room temperature	DF Manual defrost	=DF= Waiting for start sequence	ADR Peripheral address	255
	DEF Defrost	T1 Air temperature	-19	---	---
	=HI= High temperature alarm	T2 ...		---	---
	---	T3 ...		SPH Max. Setpoint	05
	=E1= Probe T1 failure	PC Access code	47	SPL Min. Setpoint	-3

TABLE 1

- 2.1 STANDBY.** Setting the parameter **OFF** to YES enables the  button that allows to put the SSD90 on standby, that is excluding output control and the buttons with the exception of the light command (manually or door controlled). With OFF=NO, the  button is inhibited. A permanent indication on display  indicates that the outputs are off.
- 2.2 NORMAL.** During normal operation the display shows the room temperature or, if the controller is being performing defrost and the parameter **DDY** is greater than 0, the indication . In this latter case, the indication will remain beyond defrost end for the time programmed with DDY.
- 2.3 ALARM.** An anomaly is reported on display through the flashing of an abbreviation indicating its cause: / high/low alarm temperature in the room;  opened door;  periodic condenser cleaning;  failure of probe T1.

2.4 INFO MENU. By pressing button **[I]** you enter the information menu. In this menu it's possible to start a manual defrost, display the instantaneous T1 temperature or set the setup access code. The selection of the data to be displayed can take place sequentially by pressing **[I]** repeatedly, or quickly by means of buttons **[▲]** and **[▼]** to scroll through the menu. You exit from the menu by pressing **[E]** or automatically after 5 seconds of no button activation.

2.5 SETUP. You have got access to the parameter menu by selecting **47** for the passcode **[C]**. To achieve this press buttons **[I]** and **[▲]** or **[▼]**. You exit from the setup by pressing button **[I]** or after 30 seconds of no button activation.

3. CONTROL PARAMETERS

The adaptation of the controller to the system that it controls is achieved through the parameters in the setup. The available parameters appear on TABLE 2 hereinafter.

You proceed from one parameter to the next/previous via button **[▲]** or **[▼]**. To display the related value, press button **[E]**, to modify it press **[E]** and simultaneously **[▲]** or **[▼]**. You exit from the setup by pressing button **[I]** or automatically after 30 seconds of no button activation.

The setpoint **SP** can be displayed and programmed even during the normal operation with buttons **[E]** and **[▲]** or **[▼]**. The setting range however remains within the limits **SPL** and **SPH**.

SPL	-40.. SPH [°]	minimum temp. set	ACT	0.. 250 [°]	condenser alarm temperature
SPH	SPL.. +250 [°]	maximum temp. set	CSD	0.. 30 [min]	compressor safety stop delay
SP	SPL.. SPH [°]	actual temperature set	CFT	-40.. +250 [°]	condenser fan temperature
HYS	-30.. 0.. +30 [°]	thermostat hysteresis	CRT	0.. 30 [min]	compressor rest time
DFR	0.. 24	defrost frequency/24h	CDC	0.. 10	cooling duty cycle for T1 fault
DLI	0.. +70 [°]	defrost end temperature	OFF	YES/NO	standby button enabling
DTO	1.. 120 [min]	defrost timeout	DS	YES/NO	door switch enabling
DTY	OFF/ELE/GAS	defrost type	LDO	YES/NO	door controlled lights
DRN	0.. 30 [min]	drain down	T2	YES/NO	probe T2 enabling
DDY	0.. 60 [min]	defrost display control	T3	YES/NO	probe T3 enabling
FPC	0.. 5	evap. fan proportional control	SCL	°C/°F	display scale
FDD	-40.. +70 [°]	fan re-start temperature	OS1	-15.. +15 [°]	probe T1 offset
ATL	-25.. 0 [°]	low alarm differential	OS2	-15.. +15 [°]	probe T2 offset
ATH	0.. +25 [°]	high alarm differential	OS3	-15.. +15 [°]	probe T3 offset
ATD	0.. 120 [min]	temperature alarm delay	SIM	0.. 100	display slowdown
ADO	0.. 120 [min]	door alarm delay	ADR	0.. 255	peripheral address
ACC	0.. 120 [weeks]	periodic condenser cleaning			

TABLE 2

4. DISPLAYS

The temperature measured by the probe T1 is treated by the microprocessor in such a way as to display it in the most meaningful way. To achieve this, it can be corrected by the offset **OS1** and displayed in degrees Celsius or Fahrenheit, depending on the value set to **SCL**.

The air temperature, before being displayed, is treated by a special algorithm allowing the simulation of a thermal mass directly proportional to the value set to **SIM**. The resulting effect is a hunting reduction on the displayed value.

The status of the compressor, evaporator fans and defrost outputs is signalled by the relevant shining dots on the display.

CAUTION: if you change **SCL** you must then **IMPERATIVELY** re-configure the parameters relating to the absolute temperatures (**SPL**, **SPH**, **SP**) and to the differential temperatures (**HYS**, **ATL**, **ATH** ...).

5. THERMOSTAT FUNCTION

5.1 Temperature control is based upon the comparison between temperature T1, the setpoint **SP** and the hysteresis **HYS**. The thermostat operation is determined by the value programmed to **HYS**: if greater than 0 there will be COOLING control, if lower than 0 there will be HEATING control, if **HYS**=0 then the thermostat will be excluded permanently.

Example 1: **HYS**=02, **SP**=-20; relay Off with **T1**=-20° and On with **T1**=-18°.

Example 2: **HYS**=-04, **SP**=70; relay Off with **T1**=+70° and On with **T1**=+66°.

The compressor cut-in is however only possible if since the off switching the minimum rest time **CRT** has elapsed. If you have to maintain a very small hysteresis **HYS**, we recommend to program a suitable value for **CRT** to ensure a long life to relay/contactors and compressor.

5.2 In consequence to a failure of probe T1, the display shows **[E]** and the output is controlled via a fixed time established by **CDC**. This determines the output running time within 10 minute cycles.

Example: **CDC**=06, 6 minutes On, 4 minutes Off.

6. DEFROST

6.1 Defrost automatically starts every time the built-in timer matches the time necessary to obtain the defrost frequency determined with **DFR**. For example, with **DFR**=4 there will be a defrost every 6 hours. With **DFR**=0 the timed defrost function is excluded.

Defrost can be started manually in the following way: from the "Info" menu select **[E]**, press button **[I]** first, then **[▲]** simultaneously.

The built-in timer is set to zero every time the unit is switched on (power supply or standby) and every time defrost starts.

6.2 Once that defrost has been started, the outputs are controlled by the parameter **DTY** according to the following table:

DTY	DEFROST	COMPRESSOR	FANS
OFF	off	off	on
ELE	on	off	off
GAS	on	on	off

6.3 Defrost lasts as long as the time **DTO**.

When this time is over, if **DRN** is greater than 0, before cooling starts all outputs will remain off for the time set to DRN. This phase, called drain down, will allow a complete ice melting and the drain of the resulting water.

7. EVAPORATOR FANS

7.1 During temperature control the evaporator fans are controlled by the parameter **FPC**. If it's greater than 0, the fans follow the compressor cycle: they turn on simultaneously with the compressor, but fan run continues after the compressor has gone off for a time proportional to its run and the parameter FPC. One unit of FPC corresponds to 20% of compressor run, therefore, for example, with FPC=2 compressor and fans start at the same time and if the compressor runs for 6 minutes, then the evaporator fans will run for a total time of 6+2 minutes and 24 seconds (40% of 6 minutes).

With FPC=0 the fans are not stopped by the proportional control.

7.2 If the SSD90 is connected to a door switch and you set parameter **DS** to YES, when the door is opened the evaporator fans stop. This control only takes place during temperature control.

7.3 When defrost is over, the evaporator fans re-start after 3 minutes.

8. ALARMS

The SSD90 allows a check on the correct thermostat operation, the door being left open, condenser periodic cleaning, in addition to the functional alarms because of power failure and probe fault. When an alarm takes place, the controller switches on the relevant relay and buzzer, flashes the alarm sources on display (see 2.3).

By pressing button , the buzzer is silenced, after that if the alarm persists, it will periodically come on for 20 seconds every hour, until the alarm ends (however the display indications and the relay always remain on). The acoustic warning re-triggering applies to all alarms with the exception of the condenser cleaning. Hereinafter is a description of the operation of the various sections:

8.1 **ATL** determines the alarm differential for temperatures lower than setpoint (cooling) or setpoint + hysteresis (heating) and **ATH** is the alarm differential for temperatures higher than the setpoint (heating) or setpoint + hysteresis (cooling). By setting to 0 one or both differentials you exclude the corresponding alarm.

Example 1: SP=-20, HYS=02, ATL=05, ATH=05; the alarm thresholds are set to -25° and -13°.

Example 2: SP=70, HYS=04, ATL=05, ATH=05; the alarm thresholds are set to +61° and +75°.





The alarm signalling can be immediate or delayed by the time **ATD** if this is greater than 0.

During defrost, the high temperature alarm is excluded.

8.2 By enabling door switch control, **DS=YES**, you also enable the relevant alarm function. Therefore, as described in 7.2, when the door is opened, the fans will be stopped immediately and after the delay time **ADO**, the compressor will be stopped too and the alarm will be signalled.

8.3 By setting parameter **ACC** to a value greater than 0, you enable a periodic condenser clean warning. In other words, when the timer counting the compressor running time matches the weeks programmed with ACC, the display will show a condenser clean request.

*Example: with ACC=16 you will obtain a warning every $16 \times 7 \times 24 = 2688$ hours of **compressor operation**. In other words, supposing that the compressor runs for 5 minutes and rests for 5 minutes, there will be a warning after about 32 weeks.*

You can only reset the timer when you have a  warning, in other words after the timer has achieved the programmed time. Therefore proceed as follows: 1) press button  and put the controller on a standby; 2) clean the condenser; 3) press button  and button  simultaneously. If the standby function has not been enabled, go to point 2 directly.

9. LIGHT SWITCH AND SERIAL COMMUNICATION

9.1 The relay controlling the lights can alternatively be controlled manually by means of button  (SMD34 only) or, if the switch is fitted, automatically when the door is opened. In this case, the parameters **DS** and **LDO** must both be set to YES. As described at 2.1 the light operation is independent from the standby.

9.2 The SSD90 can be fitted with RS485 serial port allowing the controller to exchange information with a supervisory software like the TAB. All the temperatures, status and control parameters are available for the *PC client*. The identification of every single unit within the network is given by parameter **ADR**.

WARRANTY







LAE electronic Srl warrant that their products are free of any defects in workmanship and materials for a period of 1 (one) year from date of production shown on the enclosure. LAE electronic Srl shall only repair or replace those products of which defects are due to LAE electronic Srl and recognised by their technicians. LAE electronic Srl are not liable for damages resulting from malfunctions of the products.

Defects due to exceptional operating conditions, misapplication and/or tampering will void the warranty.

All transport charges for returning the product to the manufacturer, after prior authorisation by LAE electronic Srl, and for the return to the purchaser are always for the account of the purchaser.

SSD90Axx(x-C): STANDARD SETUP

PARAMETER	RANGE	FACTORY SETTING	PARAMETER	RANGE	FACTORY SETTING
SPL	-40.. SPH [°]	-3	ACT	0.. 250 [°]	70
SPH	SPL.. +250 [°]	05	CSD	0.. 30 [min]	00
SP	SPL.. SPH [°]	01	CFT	-40.. +250 [°]	00
HYS	-30.. 0.. +30 [°]	03	CRT	0.. 30 [min]	03
DFR	0.. 24	04	CDC	0.. 10	05
DLI	0.. +70 [°]	10	OFF	YES/NO	YES
DTO	1.. 120 [min]	20	DS	YES/NO	NO
DTY	OFF/ELE/GAS	OFF	LDO	YES/NO	YES
DRN	0.. 30 [min]	00	T2	Don't modify	NO
DDY	0.. 60 [min]	15	T3	Don't modify	NO
FPC	0 ... 5	00	SCL	°C/°F	°C
FDD	-40.. +70 [°]	00	OS1	-15.. +15 [°]	00
ATL	-25.. 0 [°]	-3	OS2	-15.. +15 [°]	00
ATH	0.. +25 [°]	05	OS3	-15.. +15 [°]	00
ATD	0.. 120 [min]	30	SIM	0.. 100	03
ADO	0.. 120 [min]	05	ADR	0.. 255	01
ACC	0.. 120 [weeks]	00			

FUNCTIONS		SSD90 Series				
		A10E	A14E-A	A14E-C	A35E-C	A55E-C
Inputs		●	●	●	●	●
		●	●	●	●	●
Outputs					●	●
			●	●	●	●
					●	●
			●	●	●	●
			●	●	●	●
Options	RS485			●	●	●

* In the model A55 the defrost relay is on voltage free contacts.

WIRING DIAGRAMS

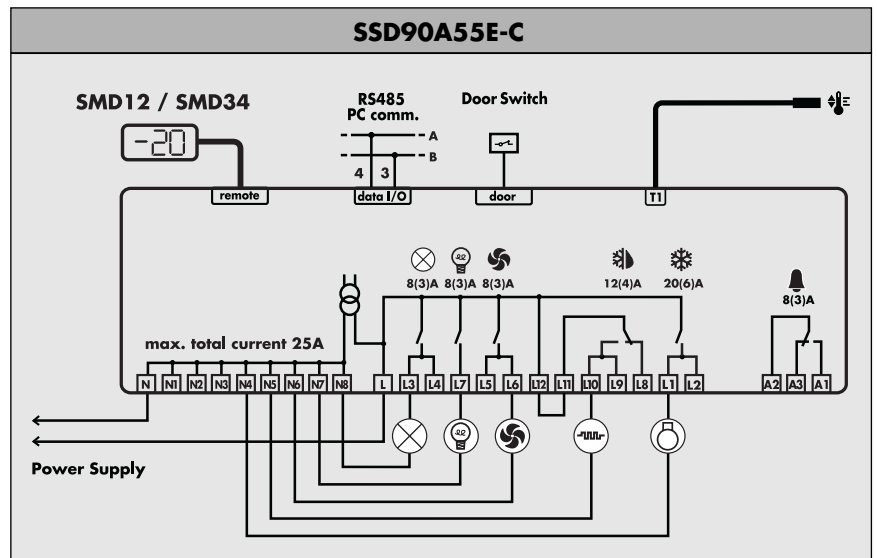
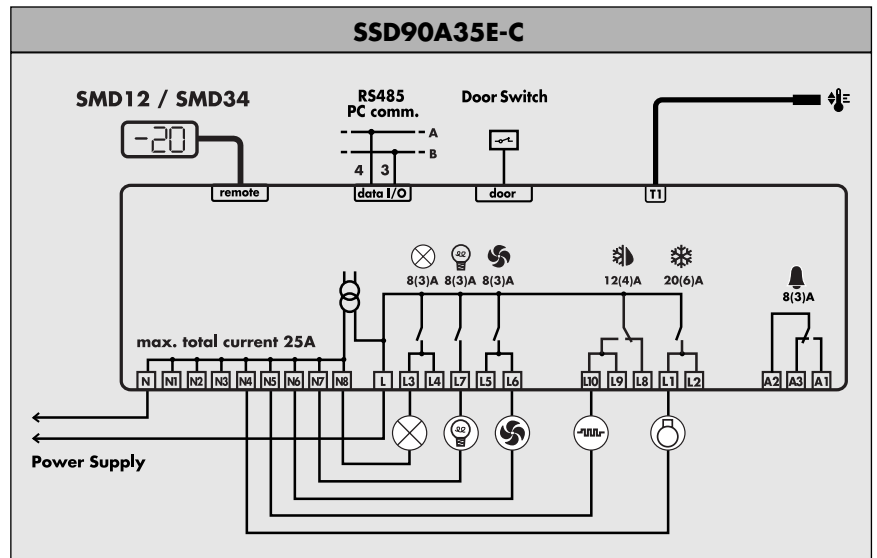

PARTNER VENEZIA • 041 5460713